User's Guide

RIGOL

Publication number DG1-070518

May 2007

DG1000 Series Function/Arbitrary Waveform Generator

© Copyright RIGOL Technologies, Inc. 2007
All Rights Reserved

- Copyright © **RIGOL** TECHNOLOGIES, INC. 2007 All Rights Reserved.
- **RIGOL** products are protected by patent law in and outside of P.R. China.
- Information in this publication replaces all the corresponding materials published previously.
- **RIGOL** Technologies, Inc. reserves the right to modify or change part of or all the specifications and pricing policies at company's sole decision.

NOTE: RIGOL is the registered trademark of **RIGOL** TECHNOLOGIES, INC.

Safety Notices

Review the following safety precautions carefully before operating the instrument to avoid any personal injury or damage to the instrument or products connected to it.

To avoid potential hazards, use the instrument in the manner specified in this user's guide.

The instrument should be serviced only by qualified personnel.

To Avoid Fire or Personal Injury

Use proper power line. Only the special power line of the products approved by the State should be used.

Insert or draw properly. Do not insert draw when the probe and the testing lead are connected with the power.

Ground the instrument. This generator is grounded through the protective terra conductor of the power cord. To avoid electric shock, the grounding conductor must be connected to the earth ground. Make sure that the instrument is properly grounded before connecting the input or output terminals.

Connect the probe properly. Connect the output terminal of the signal properly, make sure that the potential difference between the output terminal of the signal's terra line and the earth is lower than 40V DC.

The probes' ground terminals are at the same voltage level with the earth terminal of the instrument. Do not connect the ground terminals to a high voltage.

Observe All the Ratings of the Terminal. To avoid fire or shock, observe all the ratings and symbols that marked on the instrument. Read the user's guide carefully before making connections to the instrument.

Do not operate without Covers. Do not operate your generator without covers or panels.

Use Proper Fuse. Only use the fuse type and rating specified for this product.

Avoid Circuit or Wire exposed. Do not touch the exposed connections or components when the power is turn-on.

Do not operate with suspected failures. If you suspect there is damage with this product, have it inspected by qualified service personnel authorized by **RIGOL** before further operations.

Provide Proper Ventilation.

Do not operate in wet/damp conditions.

Do not operate in an explosive atmosphere.

Keep the product's surfaces clean and dry.

Safety Terms and Symbols

Terms in This Guide. These terms may appear in this manual:



WARNING: Warning statements indicate the conditions or practices that could result in injury or loss of life.



CAUTION: Caution statements indicate the conditions or practices that could result in damage to this product or other property.

Terms on the Product. These terms may appear on the product:

DANGER indicates an injury or hazard that may be immediately happen.

WARNING indicates an injury or hazard that may be not immediately happen.

CAUTION indicates that a potential damage to the instrument or other property might occur.

Symbols on the Product. These symbols may appear on the Instrument:



**Hazardous
Voltage**



**Refer to the
Instructions**



**Protective
earth terminal**



**Grounding
Terminal
of Chassis**



**Test
Grounding
Terminal**

RIGOL DG1000 Generator at a Glance

This guide covers the following two types of DG1000 Series Function/ Arbitrary Waveform Generators:

DG1021、DG1011

RIGOL DG1000 Series Function/ Arbitrary Waveform Generator adopt the DDS technology, which can provide stable, high-precision, pure and low distortion sine signal. It can also provide 5MHz square waveform with fast rising and falling edges. Its combination of excellent system features, easiness in usage and versatile functions makes this generator a perfect solution for your job now and in the future.

DG1000 Series Function/ Arbitrary Waveform Generator have clear and simple Front-Panel. The user-friendly panel layout and instructions, versatile terminals, direct graph interface, built-in instructions and help system have greatly simplified the operation process, thus, users do not have to spend a great deal of time learning and familiarizing the operation of the generator before they can use it proficiently. The built-in AM, FM, PM and FSK modulating functions generate modulated waveform at ease, without the help of a separate modulating source. The USB I/O is the standard accessory.

From the characteristics and specifications given below, you will understand how DG1000 can satisfy your measurement requirements.

- DDS technology provides precise, stable and low distortion output signal.
- 10 standard waveforms:
Sine, Square, Ramp, Pulse, Noise, Sinc, Exponential Rise, Exponential Fall, Cardiac and DC.
- 100MSa/s sampling rate, enable to edit arbitrary waveform with 14-bit, 4K points.
- Frequency characteristics:
Sine: 1 μ Hz to 20 MHz
Square: 1 μ Hz to 5 MHz
Ramp: 1 μ Hz to 150 kHz
Pulse: 500 μ Hz to 3MHz
White Noise: 5MHz bandwidth (-3dB)
Arbitrary waveform: 1 μ Hz to 5MHz

- Amplitude range: 2mV_{PP} to 10V_{PP} (50 Ω)
4mV_{PP} to 20V_{PP} (High Z)
- Abundant modulation function, various modulated waveform: AM, FM, PM and FSK.
- Linear, logarithm Sweep and Burst mode.
- Abundant I/O: External Modulation Source, External 10 MHz Reference Input, External trigger source, waveform output, synchronous digital signal output, Internal 10 MHz Reference output.
- Support USB storage device. Could store and read waveform configure parameters or the edited arbitrary waveform with USB devices. System Updating could also be performed by using USB devices.
- Standard interface: USB Host & Device
- Graph interface which shows the signal setting directly.
- Multilanguage user interface.
- Embedded Chinese/ English Help System.
- Support Chinese/ English Input.

Notice:

All the indexes described in this guide are according to DG1021, if you need to know the particular specifications about the other type, please look over "Appendix A" in Chapter 6.

Content

Safety Notices	II
RIGOL DG1000 Generator at a Glance.....	V
Chapter 1 Getting Started.....	1-1
General Inspection	1-2
Handle Adjustment.....	1-3
The Front/Rear Panel.....	1-4
The DG1000 User Interface	1-7
To Set a Waveform	1-8
To Set Modulate/ Sweep/Burst.....	1-11
To Set Trigger/Output	1-13
To Use Digital Input.....	1-14
To Use Store/Utility/Help Function.....	1-15
Chapter 2 Operating Your Generator.....	2-1
The Menu/Graph Mode.....	2-2
To Set Sine Signals.....	2-3
To Set Square Signals.....	2-7
To Set Ramp Signals.....	2-10
To Set Pulse Signals.....	2-12
To Set Noise Signals.....	2-14
To Set Arbitrary Signals.....	2-15
To Set Counter.....	2-27
To Generate the Modulated Waveform.....	2-32
To Generate Sweep.....	2-41
To Generate Burst	2-44
To Store and Recall	2-49
To Set the Utility Function.....	2-56
How to Use the Built-in Help System.....	2-74
Chapter 3 Application & Examples	3-1
Example 1: To Generate a Sine Wave	3-1
Example 2: To generate a Square Wave.....	3-2
Example 3: To generate a Ramp Wave.....	3-3
Example 4: To generate a Pulse Wave.....	3-4
Example 5: To Generate a Noise Wave.....	3-5
© Copyright RIGOL Technologies, Inc. 2007	VII

Example 6: To generate Arbitrary Waveform 3-6

Example 7: To Generate an Arbitrary Waveform 3-7

Example 8: To Generate an AM Waveform 3-9

Example 9: To Generate an FSK Waveform..... 3-11

Example 10: To generate a Linear Sweep Waveform..... 3-13

Example 11: To generate a Burst Waveform 3-15

Example 12: To measure the frequency..... 3-17

Chapter 4 Prompt messages & troubleshooting..... 4-1

Prompting Messages 4-1

Troubleshooting 4-18

Chapter 5 Support & Service..... 5-1

Chapter 6 Appendix..... 6-1

Appendix A Specifications..... 6-1

Appendix B DG1000 Series Accessories 6-9

Appendix C General Care and Cleaning..... 6-10

Chapter 1 Getting Started

This chapter covers the following topics:

- General Inspection
- To Adjust the Handle
- The Front/rear Panel of DG1000 Series
- The User Interface of DG1000 Series
- To Set a Waveform
- To Set Modulation/Sweep/Burst
- To Set Trigger/Output and Counter
- To Use Digital Input
- To Use Store/Utility/Help Function

General Inspection

When you get a new DG1000 Series Function/ Arbitrary Waveform Generator, you are suggested to take the following steps to inspect the instrument.

1. Inspect the shipping container for damage.

If there are damages in the packing or foam, keep them until the whole machine and the accessories pass the electric and mechanical testing.

2. Check the accessories.

Accessories supplied with the instrument are listed in chapter 6 "Appendix B: DG1000 Series Accessories". If the contents are incomplete or damaged, please contact the local selling representative of **RIGOL**.

3. Inspect the instrument.

In case of any mechanical damage or defect, or if the instrument does not operate properly or pass performance tests, notify your **RIGOL** Sales Representative.

If the shipping container is damaged, or the cushioning materials show signs of stress, notify the carrier of your **RIGOL** sales office. Keep the shipping materials for the carrier's inspection. **RIGOL** offices will arrange for repair or replacement at **RIGOL's** option without waiting for claim settlement.

Handle Adjustment

To adjust the handle position of DG1000 Function/ Arbitrary Waveform Generator, please grip the handle by the sides and pull it outward. Then, make the handle rotate to the desired position. The operating methods are shown below in graphs 1-1 and 1-2.

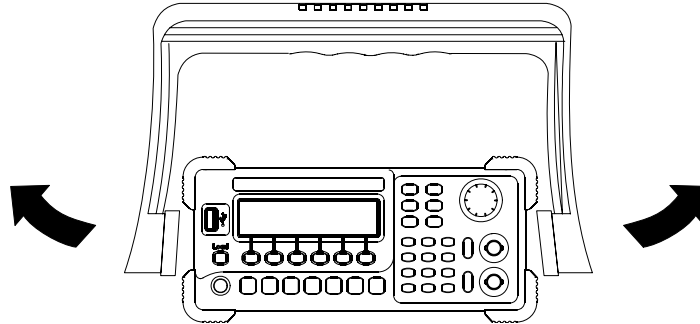

Figure 1-1 The method of adjusting the handle

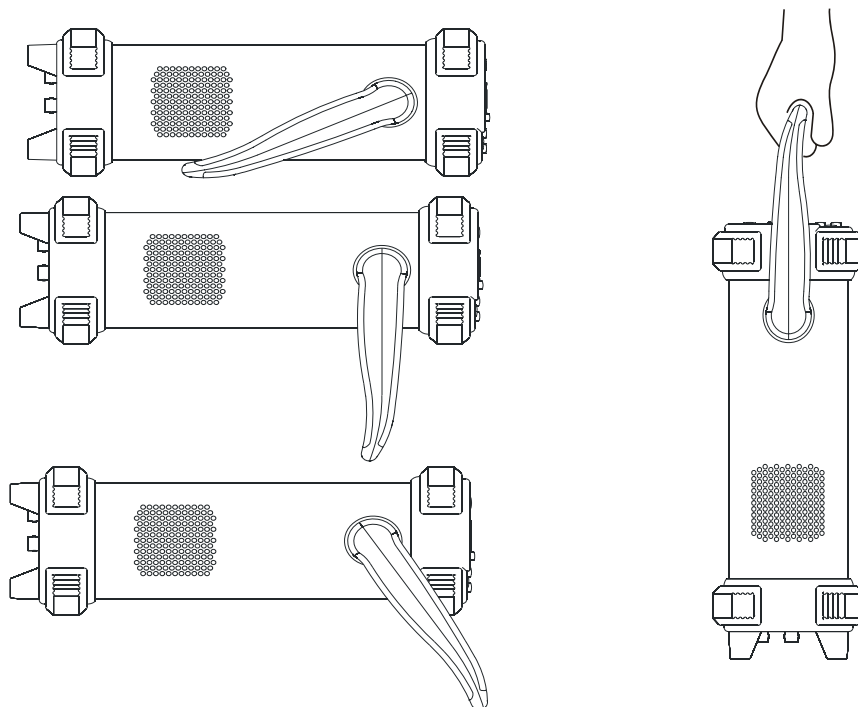

Figure 1-2 Adjustable Positions

The Front/Rear Panel

When you get a new DG1000 Series Function/ Arbitrary Waveform Generator, first you need to know how to operate the front/ Rear panel correctly. This chapter will make a brief introduction and description for the operation and functions of the Front/ Rear Panel.

The Front Panel at a Glance

DG1000 Series Function/ Arbitrary Waveform Generator has clear and simple front panel. See Figure 1-3 and Figure 1-4. The Front Panel has a knob, functional keys and menu buttons. The 6 grey buttons below the screen are menu buttons, by using which you can choose different options on the current menu. The rests are the functional keys, with which you can enter different function menus or obtain specific functional applications directly.

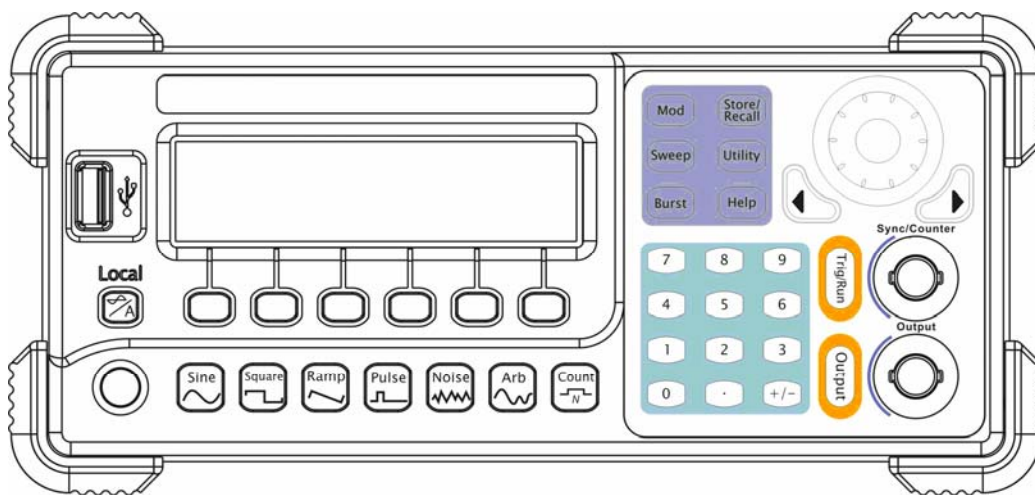

Figure 1-3
Front Panel for DG1000 Series

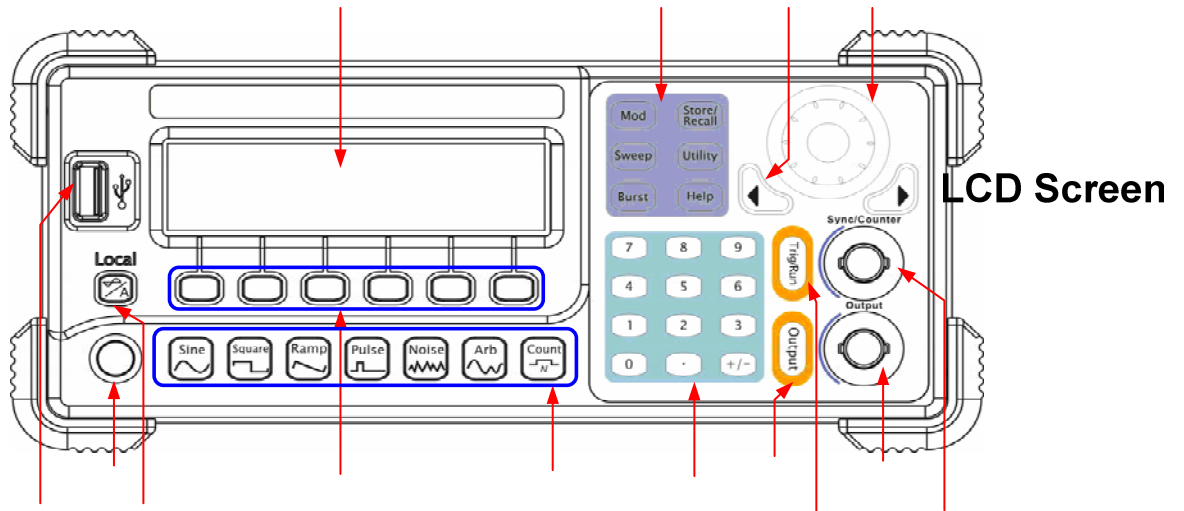

Figure 1-4
Front Panel Operation Instruction for DG1000 Series

The Rear Panel at a Glance

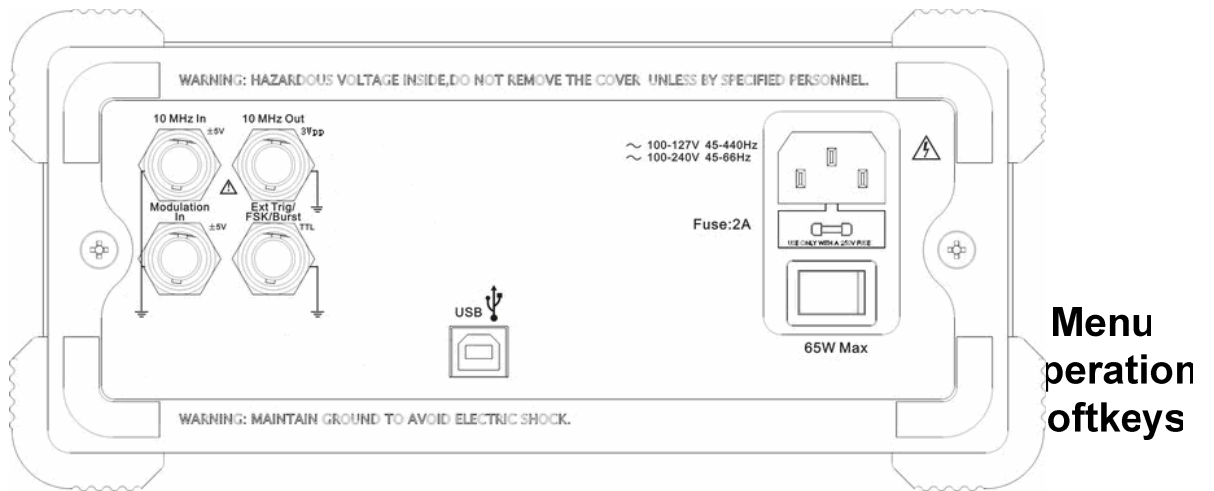

Figure 1-5
Rear Panel for DG1000 Series

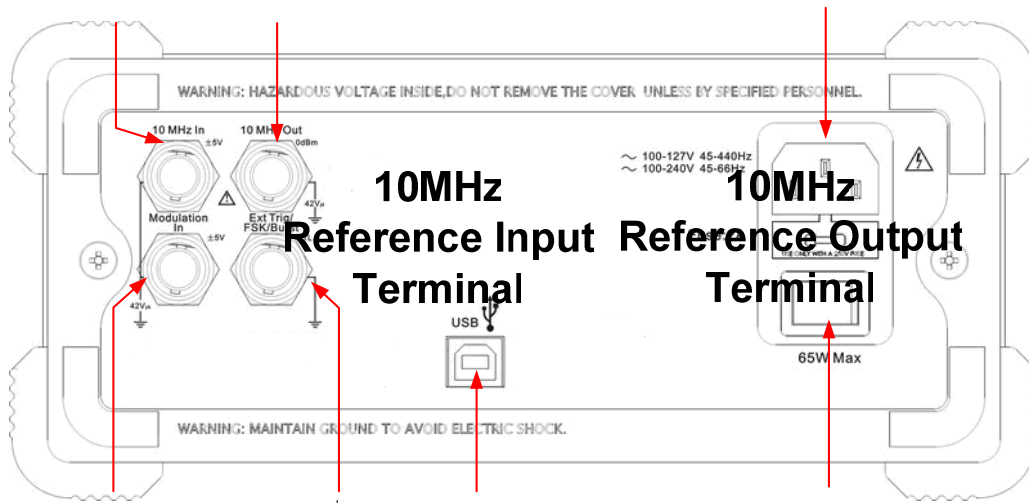



Figure 1-6
Rear Panel Operation Instruction for DG1000 Series

**Modulation Input
Terminal**

**External
Trig/FSK/Burst**

USB Device

The DG1000 User Interface

DG1000 Series Function/ Arbitrary Waveform Generator provide two Display modes: Menu and Graph. Under the Menu Display mode, the display interface is divided into 4 parts: state, waveform icon, operation menu, and parameter display. See Figure 1-7. Under the Graph display mode, you can check the current waveform parameters in the graphics. The display interface is also divided into 4 parts: state, parameter display, display menu button and waveform display. See Figure 1-8. The operation menu will appear at the bottom of the screen when you press any menu button. These two display modes can be switched to each other by pressing the  button.

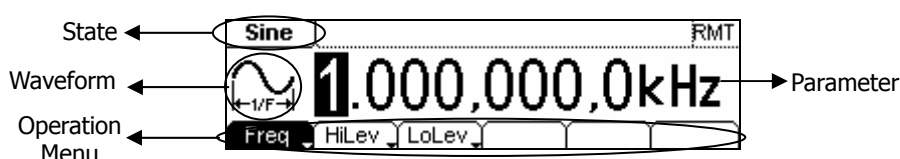

Figure 1-7

The menu Display Mode Interface Instruction

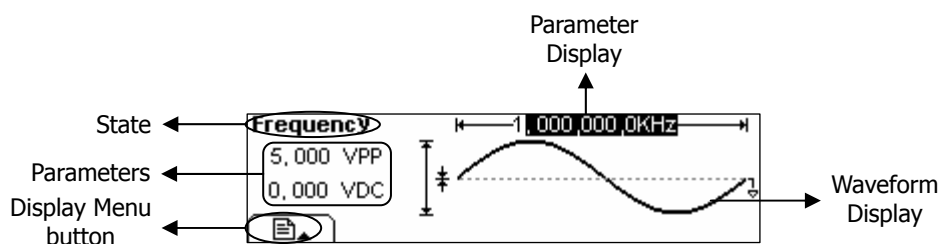





Figure 1-8

Graph Mode Display Interface Instruction

Note:

The signs for the buttons in this guide are the same as the panel buttons. Please note that the signs for the functional buttons on the operation panel are represented by squared words, such as , which represents the transparent functional key with Sine on it on the front panel, while the menu buttons are represented by shadow words such as , which means the "Frequency" option in the  menu.

To Set a Waveform

At the left of the operation panel, there is a set of buttons with waveform icon. See Figure 1-9. The exercise below will help you to be familiar with the waveform selection settings. The instructions of the waveform setting are all carried out in the Menu Display Mode.



Figure 1-9
Waveform Selection Buttons

1. Press **Sine** button, and the waveform icon turns into Sine with a "Sine" typeface in the state area. DG1000 Series Generator can generate Sine signal with frequency from 1 μ Hz to 20MHz. By setting Frequency/Period, Amplitude/ High Level, Offset/ Low level, sine signal with different parameters can be generated.

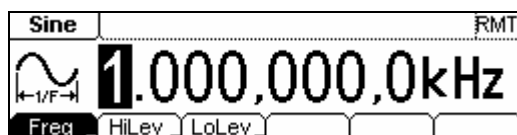

Figure 1-10
Sine Signal in the Menu Display Mode

As shown in Figure 1-10, the default signal parameters are: 1kHz Frequency, 5.0 V_{PP} Amplitude and 0 V_{DC} Offset.

2. Press **Square** button, and the waveform icon turns into Square with a "Square" typeface in the state area. DG1000 Series Generator can generate Square signal with frequency from 1 μ Hz to 5MHz and variable duty cycle. By setting Frequency/Period, Amplitude/ High Level, Offset/ Low level, and Duty Cycle, Square signal with different parameters can be generated.

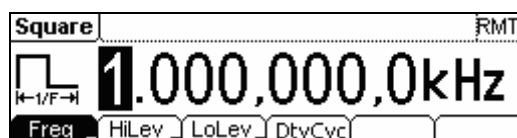

Figure 1-11
Square Signal in the Menu Display Mode

As shown in Figure 1-11, the default signal parameters are: 1kHz Frequency, 5.0 V_{PP} Amplitude, 0 V_{DC} Offset and 50% Duty Cycle.

- Press **Ramp** button, and the waveform icon turns into Ramp with a “Ramp” typeface in the state area. DG1000 Series Generator can generate Ramp signal with frequency from 1μHz to 150 kHz and variable Symmetry. By setting Frequency/Period, Amplitude/ High Level, Offset/ Low level, and Symmetry, Ramp signal with different parameters can be generated.

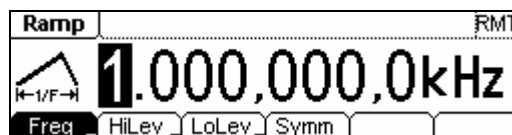

Figure 1-12
Ramp Signal in the Menu Display Mode

As shown in Figure 1-12, the default signal parameters are: 1kHz Frequency, 5.0 V_{PP} Amplitude, 0 V_{DC} Offset and 50% Symmetry.

- Press **Pulse** button, and the waveform icon turns into Pulse with a “Pulse” typeface in the state area. DG1000 Series Generator can generate Pulse signal with frequency from 500μHz to 3MHz and variable Pulse Width. By setting Frequency/Period, Amplitude/ High Level, Offset/ Low level, Pulse Width and Duty Cycle, Pulse signal with different parameters can be generated.



Figure 1-13
Pulse Signal in the Menu Display Mode

As shown in Figure 1-13, the default signal parameters are: 1kHz Frequency, 5.0 V_{PP} Amplitude, 0 V_{DC} Offset, 200μs Pulse Width.

- Press **Noise** button, and the waveform icon turns into Noise with a “Noise” typeface in the state area. DG1000 Series Generator can generate Noise signal with Band Width up to 5MHz. By setting Amplitude/ High Level, Offset/ Low level, Noise signal with different parameters can be generated.



Figure 1-14
Noise Signal in the Menu Display Mode

As shown in Figure 1-14, the default signal parameters are: 5.0 V_{PP} Amplitude and 0 V_{DC} Offset.

- Press **Arb** button, and the waveform icon turns into Arb with an “Arb” typeface in the state area. DG1000 Series Generator can generate repeatable arbitrary waveform signals with at most 4K points and 3MHz frequency. By setting Frequency/Period, Amplitude/ High Level, Offset/ Low level, arbitrary waveform signals with different parameters can be generated.

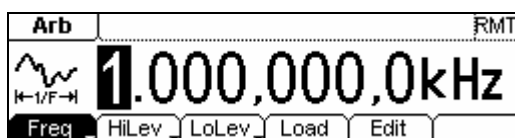

Figure 1-15
Arbitrary waveform Signal in the Menu Display Mode

As shown in Figure 1-15, the default Exponential Rise Signal parameters are: 1kHz Frequency, 5.0 V_{PP} Amplitude and 0 V_{DC} Offset.

- Press **Count** button, and the waveform icon turns into Arb with an “Count” typeface in the state area. Select “Freq”, “Period”, “PWidth”, “NWidth”, the screen will display corresponding measure result. Select “Setup” to set the parameters of input coupling method, sensitivity, trigger level and high frequency on/off.



Figure 1-16
General interface of the counter

To Set Modulate/ Sweep/Burst

As shown in Figure 1-17, there are three buttons on the front panel, which are used for Modulating, sweeping and bursting settings. The instructions below will help you familiarize with the setting of these functions.



Figure 1-17

Modulate/ Sweep/ Burst button

1. Press **Mod** button, and a Modulated waveforms will be generated. Parameters are set by using the menu buttons. The modulated waveform can be changed by changing the parameters such as Type, Internal/external Modulation, Depth, Frequency, Waveform, etc.

DG1000 Series can modulate waveform using AM, FM, PM and FSK. Sine, Square, Ramp or Arbitrary waveforms can be modulated (Pulse, Noise and DC cannot be modulated).



Figure 1-18

Modulated Waveform Signal in the Menu Display Mode

2. Press **Sweep** button, Sine, Square, Ramp or Arbitrary waveform can be swept (Pulse, Noise and DC can not be swept). In the Sweep Mode, DG1000 Series generate signal with variable frequencies.



Figure 1-19
Sweep Waveform Signal in the Menu Display Mode

3. Press **Burst** button, Burst for Sine, Square, Ramp, Pulse or Arbitrary waveform can be generated (Noise can only be used in the gated Burst).

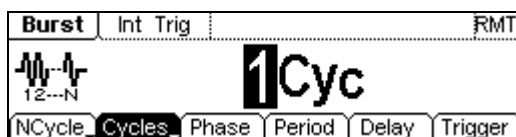

Figure 1-20
Burst Waveform Signal in the Menu Display Mode

Term Explanation

Burst: Output Waveforms with set cycle times

Burst can last for certain times of waveform cycle (N-Cycle Burst) or be controlled by external gated signals (Gated Burst). Burst applies to all kinds of waveforms, but noise can only be used in gated burst.

To Set Trigger/Output

As shown in Figure 1-21, there are two buttons on the right side of the operation panel, which are used to set Trigger and Output Control. The instruction below will help you to be familiar with these functions.



Figure 1-21
Trigger/ Output Button

1. Press **Trig/Run** Button, choose internal/ external or manual Trigger (Manual Trigger can only be used in Sweep and N-Cycle Burst)

The default setting for Trigger is "Internal". In this mode, when the Sweep or Burst Mode is also selected, the Generator will continuously generate burst. At this time, press **Trig/Run** button, the instrument will shift from the "Automatic" Trigger mode into "Manual" Trigger mode.

When the generator uses the "External" Trigger Mode, if the Sweep or the Burst Mode is selected, signal will be continuously generated. At this time, press **Trig/Run** button, the instrument state will not change, and it will show "The instrument has already been triggered".

Every time you press the **Trig/Run** button, "Manual" Trigger will start a sweep or generate a burst. Press the button again, and the generator will be triggered again.

2. Press **Output** Button, activate or deactivate the output signal.
If an overload message is shown, disconnect the external equipment from the output terminals and press **Output** button, reactivate the output terminal.

To Use Digital Input

As shown in Figure 1-22, there are two groups of buttons on the operation panel, which are direction button, the knob and the keypad. The instruction below will help you to be familiar with the Digital Input Function.

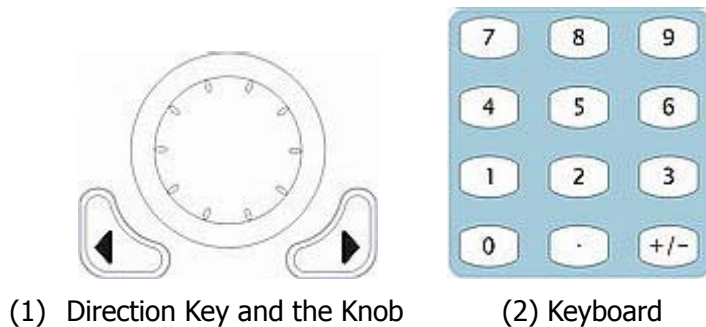

Figure 1-22
Front Panel Digital Input

1. Use the Direction keys to move the cursor left or right. Rotate the knob to change a digit (clockwise to increase).
2. Use the Keypad to set the parameters values of the waveforms, which can change its value directly.

To Use Store/Utility/Help Function

As shown in Figure 1-23, there are three buttons on the operation panel, which are used to call the store/recall, utility and help function. The instruction below will help you to be familiar with these Functions.

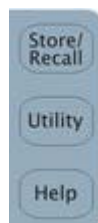

Figure 1-23

Store/Recall, Utility and Help Button

1. The **Store/Recall** Button is used to store waveform data and configure information.
2. The **Utility** Button is used to set the auxiliary system function, change the output configure parameters, interface setting, system setting information or perform the instrument self-test and read the calibration information, etc.
3. The **Help** Button is used to read the help information.

Operation Instruction















To get help:

To get help on any key of the front panel, press the key and last for 1 second, then the help message will appear.

Chapter 2 Operating Your Generator

By now you have got a brief understanding of DG1000 series with the front/rear panel, every function control area and keys. You should also know how to set your function/ arbitrary waveform generator. If you are not familiar with these operations, please read Chapter 1 "Getting Started" again.

This chapter covers the following topics:

- Menu/Graph Mode ()
- Setting Sine Signal ()
- Setting Square Signal ()
- Setting Ramp Signal ()
- Setting Pulse Signal ()
- Setting Noise Signal ()
- Setting Arb Signal ()
- Setting counter ()
- Output Modulated Signal ()
- Output Sweep Signal ()
- Output Burst Signal ()
- Trigger Sweep or Burst ()
- Store/Recall ()
- Utility Setting ()
- Help System ()

You are suggested to read this chapter carefully so as to understand DG1000 Series Generator's versatile waveform setting Functions and the other operation methods.

The Menu/Graph Mode

To activate the Graph Mode

Press , enter the Graph Mode. The name of the current selection parameter is shown on the top left corner of the screen, and its value is shown in inverse color. See Figure 2-1.

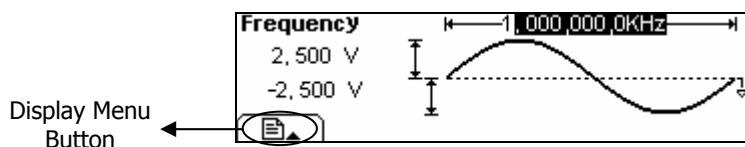

Figure 2-1
Graph Mode Interface

To Select the Desired Parameter

To select the specific parameters, please press any menu button and the operation menu will pop out. Press the corresponding button to set the parameter. For example, if you want to change the frequency, press any menu button and select **Freq** menu. The direction button will help you find your desired parameter digit and change its value with the knob or the keypad, see Figure 2-2. In the Graph Mode, the parameters will still switch at a second press on the button, such as **Amp/HiLev**.

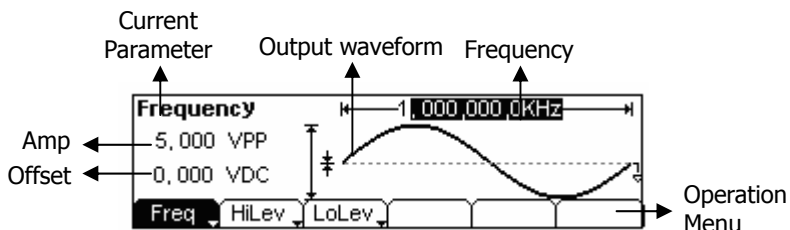



Figure 2-2
Setting the parameters in the Graph Mode

To Quit the Graph Mode

To quit the Graph Mode, press the  and return the Menu Mode.

To Set Sine Signals

In the Menu Mode, press **Sine** Key to call the Sine operation. The top left corner of the screen will show the name of the current waveform, see Figure 2-3. The output Sine waveform parameters are set using the Sine operation menu.

The parameters for Sine waveforms are: Frequency/ Period, Amplitude/ High Level, Offset/ Low Level. Different Sine Signals are generated by using these parameters. As is shown in Figure 2-4, select **Freq** in the operation menu and the frequency parameter will show in the parameter area. Users then can change the frequency by using the direction button and the knob or the keypad.

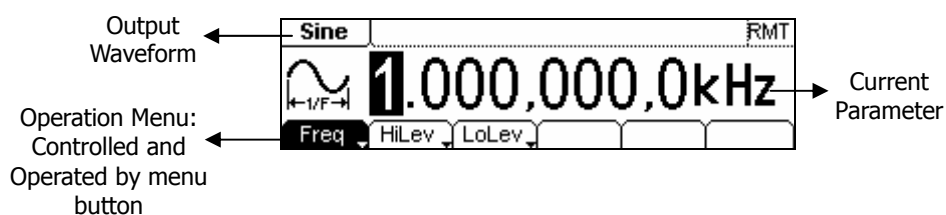

Figure 2-3 Sine Signal Parameter Setting Interface

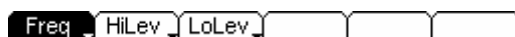

Figure 2-4 Operation Menu

Table 2-1 Operation Menu for Sine Signal

Function Menu	Settings	Explanation
Frequency/ Period		Setting the signal's frequency or period; the current parameter will switch at a second press.
Amplitude/ High Level		Setting the signal's Amplitude or High Level; the current parameter will switch at a second press.
Offset/Low Level		Setting the signal's Offset or Low Level; the current parameter will switch at a second press

To Set the Output Frequency/Period

(1) Press **Sine** → **Freq/Period** → **Freq**, to set the frequency parameter.

The frequency shown on the screen is the default value when the instrument is powered or the set value beforehand. When setting the function, if the current value is valid for the new waveform, it will be used sequentially. If you want to set the period for the waveform, press **Freq/Period** button again, switch to the **Period** parameter (The current operation is displayed in inverse color).

(2) Input the desired frequency.

Use the keypad to input the parameter value directly, and press the corresponding button to select the parameter unit. Or you can use the direction button to select the digit you want to edit, and then use the knob to change its value.

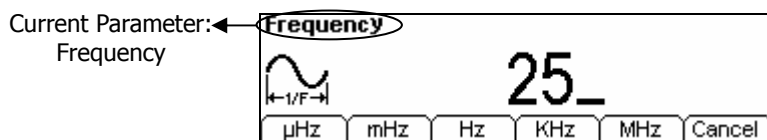

Figure 2-5 Setting the Frequency

Instruction:

When using the keypad to enter the digit, you can use the Left direction button to move the cursor backward and delete or change the value of the previous digit.

When using the knob to input, use the direction buttons to select the digit you want to edit and rotate the knob to change its value.

To Set the Output Amplitude

(1) Press **Sine** → **Ampl/HiLev** → **Ampl**, to set the amplitude.

The amplitude shown on the screen is the default value when the instrument is powered or the set value beforehand. When changing the function, if the current value is valid for the new waveform, it will be used sequentially. If you want to set the waveform by high Level or Low Level, press **Ampl/HiLev** or **Offset/LoLev** again, switch to **HiLev** or **LoLev** parameter (The current operation is displayed in inverse color).

(2) Input the desired Amplitude

Use the keypad or the knob to input the desired value, choose the unit, and press the corresponding button.

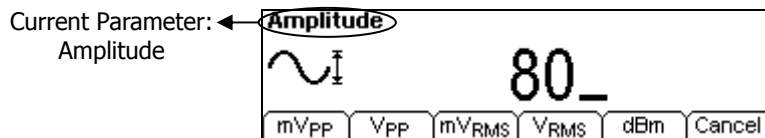

Figure 2-6 Setting the Amplitude

To Set the DC Offset

(1) Press **Sine** → **Offset/LoLev** → **Offset**, to set the offset.

The offset shown on the screen is the default value when the instrument is powered or the set value beforehand. When changing the function, if the current value is valid for the new waveform, it will be used sequentially.

(2) Input the desired Offset

Use the keypad or the knob to input the desired value, choose the unit, and press the corresponding button.

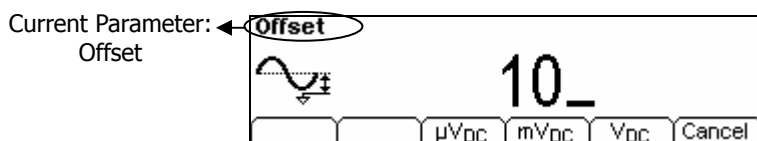

Figure 2-7 Setting the Offset

In the Graph Mode, the waveform is shown in Figure 2-8.

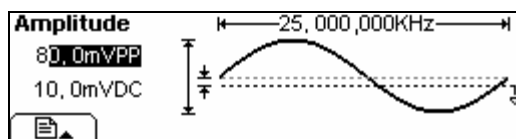

Figure 2-8 Waveform Parameter in the Graph Mode

Notes: the Setting of any waveform for DC Offset is the same as sine wave, so we will not cover this topic hereon.

To Set Square Signals

Press **Square** button, in the Normal Mode, the operation menu will appear at the bottom of the screen, see Figure 2-9. Set the Square parameters by using the operation menu.

The parameters for Square waveforms are: Frequency/ Period, Amplitude/ High Level, Offset/ Low Level and Duty Cycle. See Figure 2-10. In the operation menu, select **DtyCyc**, and the corresponding parameter will be displayed in inverse color for which users can make a change.



Figure 2-9 Square Signal Parameter Setting Interface



Figure 2-10 Operation Menu

Table 2-2 Square Signal Operation Menu

Function Menu	Settings	Explanation
Frequency/ Period		Setting the signal's frequency or period; the current parameter will switch at a second press.
Amplitude/ High Level		Setting the signal's Amplitude or High Level; the current parameter will switch at a second press.
Offset/Low Level		Setting the signal's Offset or Low Level; the current parameter will switch at a second press
Duty Cycle		Setting the Duty Cycle for Square Waveform

Term Explanation:

Duty Cycle: The percentage that the High Level takes up in the whole Period.

Please Note : for the Frequency	Duty Cycle Value
Below 3MHz(included):	20% to 80%
From 3MHz to 4MHz (included):	40% to 60%
From 4MHz to 5MHz (included):	50%

To Set the Duty Cycle

(1) Press **Square** → **DtyCyc**, to set the Duty Cycle.

The Duty Cycle shown on the screen is the default value when the instrument is powered or the set value beforehand. When changing the function, if the current value is valid for the new waveform, it will be used sequentially.

(2) Input the desired Duty Cycle

Use the keypad or the knob to input the desired value, choose the unit, and press the corresponding button. The Generator will change the waveform immediately.

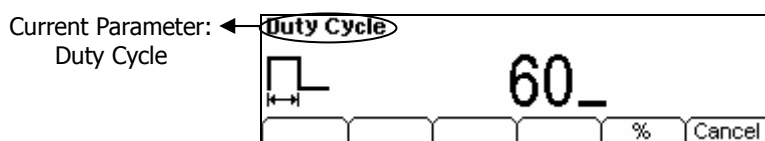

Figure 2-11 Setting the Duty Cycle

In the Graph Mode, the waveform is shown in Figure 2-12.

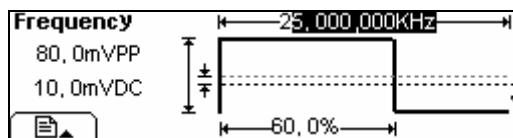

Figure 2-12 Waveform Parameters in the Graph Mode

To Set Ramp Signals

Press **Ramp** button, in the Normal Mode, the operation menu will appear at the bottom of the screen, see Figure 2-13. Set the Ramp parameters by using the operation menu.

The parameters for Ramp waveforms are: Frequency/ Period, Amplitude/ High Level, Offset/ Low Level and Symmetry. See Figure 2-14. In the operation menu, select **Symm**, and the corresponding parameter will be displayed in inverse color for which users can make a change.



Figure 2-13 Ramp Signal Parameter Setting Interface



Figure 2-14 Operation Menu

Table 2-3 Ramp Signal Operation Menu

Function Menu	Settings	Explanation
Frequency/ Period		Setting the signal's frequency or period; the current parameter will switch at a second press.
Amplitude/ High Level		Setting the signal's Amplitude or High Level; the current parameter will switch at a second press.
Offset/Low Level		Setting the signal's Offset or Low Level; the current parameter will switch at a second press
Symmetry		Setting the Symmetry for Ramp Waveform

Term Explanation:

Symmetry: The percentage that the Rising Period takes up in the whole Period.

Input Range: 0~100%

To Set the Symmetry

(1) Press **Ramp** → **Symm**, to set the Symmetry.

The Symmetry shown on the screen is the default value when the instrument is powered or the set value beforehand. When changing the function, if the current value is valid for the new waveform, it will be used sequentially.

(2) Input the desired Symmetry.

Use the keypad or the knob to input the desired value, choose the unit, and press the corresponding button. The Generator will change the waveform immediately.

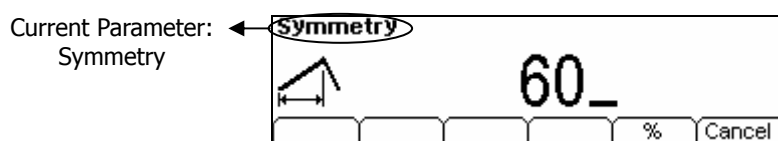

Figure 2-15 Setting the Symmetry

In the Graph Mode, the waveform is shown in Figure 2-16.

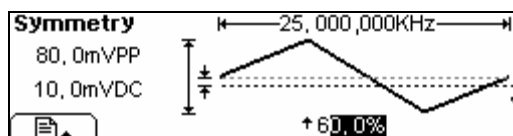

Figure 2-16 Waveform Parameter in the Graph Mode

To Set Pulse Signals

Press **Pulse** button, in the Normal Mode, the operation menu will appear at the bottom of the screen, see Figure 2-17. Set the Pulse parameters by using the operation menu.

The parameters for Pulse waveforms are: Frequency/ Period, Amplitude/ High Level, Offset/ Low Level Pulse Width and Duty Cycle. See Figure 2-18. In the operation menu, select **Width**, and the corresponding parameter will be displayed in inverse color for which users can make a change.



Figure 2-17 Pulse Signal Parameter Setting Interface



Figure 2-18 Operation Menu

Table 2-4 Pulse Signal Operation Menu

Function Menu	Settings	Explanation
Frequency/ Period		Setting the signal's frequency or period; the current parameter will switch at a second press.
Amplitude/ High Level		Setting the signal's Amplitude or High Level; the current parameter will switch at a second press.
Offset/Low Level		Setting the signal's Offset or Low Level; the current parameter will switch at a second press.
Width/ DtyCyc		Setting the Pulse Width or Duty Cycle for Pulse Waveform.

Term Explanation:

Pulse Width: The time span between thresholds of 50% of the rising edge amplitude to the next 50% of the falling edge amplitude.

To Set the Pulse Width

(1) Press **Pulse** → **Width**, to set the Pulse Width.

The Pulse Width shown on the screen is the default value when the instrument is powered or the set value beforehand. When changing the function, if the current value is valid for the new waveform, it will be used sequentially.

(2) Input the desired Pulse Width

Use the keypad or the knob to input the desired value, choose the unit, and press the corresponding button. The Generator will change the waveform immediately.

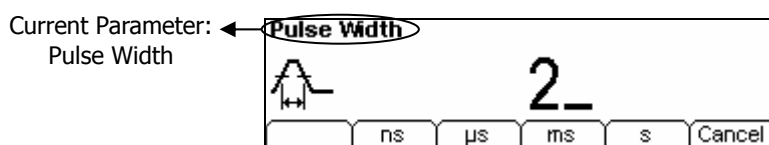

Figure 2-19 Setting the Pulse Width

In the Graph Mode, the waveform is shown in Figure 2-20.

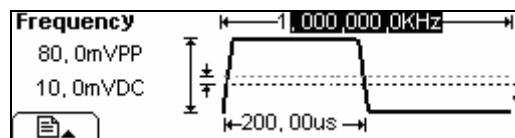

Figure 2-20 Waveform parameters in the Graph mode

Note: Pulse width and Duty cycle are equivalent, once a parameter is changed, the other one will change accordingly. For instance, the current period is 1ms, the pulse width is 500μs and the duty cycle is 50%, when setting the pulse width to be 200μs, the duty cycle will become 20%.

To Set Noise Signals

Press **Noise** button, in the Normal Mode, the operation menu will appear at the bottom of the screen, see Figure 2-21. Set the Pulse parameters by using the operation menu.

The parameters for Noise waveforms are: Amplitude/ High Level and Offset/ Low Level. See Figure 2-22. In the operation menu, select **Ampl**, and the corresponding amplitude will be displayed in inverse color for which users can make a change for the amplitude of Noise, which has no frequency or period.



Figure 2-21 Noise Signal Parameter Setting Interface

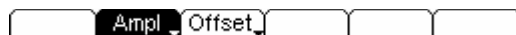

Figure 2-22 Operation Menu

Table 2-5 Noise Signal Operation Menu

Function Menu	Settings	Explanation
Amplitude/ High Level		Setting the signal's Amplitude or High Level; the current parameter will switch at a second press.
Offset/Low Level		Setting the signal's Offset or Low Level; the current parameter will switch at a second press

In the Graph Mode, the waveform is shown in Figure 2-23.

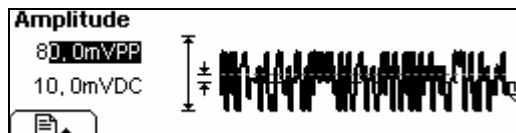

Figure 2-23 Waveform Parameter in the Graph Mode

To Set Arbitrary Signals

Press **Arb** button, in the Normal Mode, the operation menu will appear at the bottom of the screen, see Figure 2-24. Set the Arbitrary Waveform parameters by using the operation menu.

Arbitrary Signals are divided into two categories: the built-in optional system waveforms and the user-definable arbitrary waveforms. The parameters for Arbitrary Waveforms are: Frequency/ Period, Amplitude/ High Level and Offset/ Low Level. See Figure 2-25. In the operation menu, select **Freq**, and the corresponding frequency will be displayed in inverse color for which users can make a change.

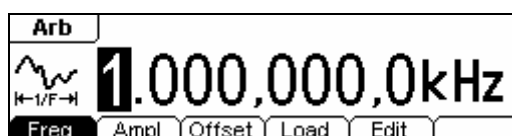

Figure 2-24
Arbitrary Signal Parameter Setting Interface



Figure 2-25 Operation Menu

Table 2-6 Arbitrary Signal Operation Menu

Function Menu	Settings	Explanation
Frequency/ Period		Setting the signal's frequency or period; the current parameter will switch at a second press.
Amplitude/ High Level		Setting the signal's Amplitude or High Level; the current parameter will switch at a second press.
Offset/Low Level		Setting the signal's Offset or Low Level; the current parameter will switch at a second press.
Load		Select the built-in Arbitrary Signal as Output.
Edit		Create and Edit Arbitrary Waveform.

To Select the built-in Arbitrary Waveform

There are five built-in Arbitrary Waveforms and user-definable Arbitrary Waveforms inside the Generator. To select one of them, following the instructions below:

Press **Arb** → **Load**, enter the interface shown below.



Figure 2-26 Operation Menu

Table 2-7 Selection Menu for Built-in Arbitrary Waveform

Function Menu	Settings	Explanation
Built-in		Select one of the five built-in Arbitrary Waveforms (See Table 2-8)
Stored		Select one of Arbitrary Waveforms stored in the Non-volatile memory.
Volatile		Select one of Arbitrary Waveforms stored in the Volatile memory. When a new waveform is created, the old one will be erased.
Delete		Delete one of the Arbitrary Waveforms stored in the Non-volatile memory. The five Built-in Waveforms can not be deleted.
↩		Cancel the current operation, and return to the upper menu. (The rest are the same and will not be covered)

Instructions:

1. When there is no waveform stored in the Non-Volatile Memory, the **Stored** Menu and the **Delete** Menu will hide.
2. When there is no waveform in the Volatile Memory, the **Volatile** menu will hide.

1. To Select the Built-in Waveform

Press **Arb** → **Load** → **BuiltIn**, enter the following interface.



Figure 2-27 Operation Menu

Table 2-8 The Built-in Arbitrary Waveforms Menu

Function Menu	Settings	Explanation
ExpRise		Select the built-in Exponential Rise Waveform
ExpFall		Select the built-in Exponential Fall Waveform
NegRamp		Select the built-in Negative Ramp Waveform
Sinc		Select the built-in Sinc Waveform. $\text{Sinc} = \text{Sin}(x)/x$
Cardiac		Select the built-in Cardiac Waveform
↕		Cancel

In the Graph Mode, the waveform is shown in Figure 2-28.

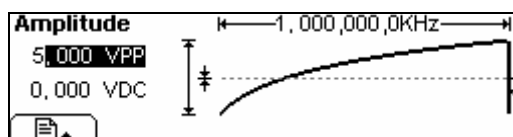

Figure 2-28

Waveform Parameter in the Graph Mode (Exponential Rising Waveform)

2. To Select the Stored Waveform

Press **Arb** → **Load** → **Stored**, and enter the following interface. Select the desired waveform document which will be displayed in inverse color and press **Recall** to recall it from the memory.



Figure 2-29 Operation Menu

Table 2-9 The Stored Arbitrary Waveform Menu

Function Menu	Settings	Explanation
Disk	Local	Choose display route for the system information
	U Disk (When U Disk is connected)	
Type	State	Setting of the Generator
	Data	Arbitrary waveform file
	All	All types of documentation
Recall		Recall the waveform or Setting information in the specific position in the memory.
Store		Save the waveform to the appointed place
Remove		Remove any waveform that has been stored in the memory

Instructions:

When there is no waveform stored in the **Arb1**, **Arb2**, **Arb3** and **Arb4**, this menu will hide (The rest is the same and will not explain again)

3. To Remove the Waveform

Press **Arb** → **Load** → **Stored**, and enter the following interface. Select the waveform documentation to be deleted which will be displayed in inverse color, and then press **Remove** to delete it.



Figure 2-30 Operation Menu

Table 2-10 Waveform Removal Menu

Function Menu	Settings	Explanation
Disk	Local	Choose display route for the system information
	U Disk (When U disk is connected)	
Type	State	Setting of the Generator
	Data	Arbitrary waveform file
	All	All types of documentation
Recall		Recall the waveform or Setting information in the specific position in the memory.
Store		Save the waveform to the appointed place
Remove		Remove any waveform that has been stored in the memory

To Edit the Arbitrary Waveform

The Generator allows users to edit Arbitrary Waveforms, which can create any new waveform by initializing points. The operation steps are as follows:

Press **Arb** → **Edit**, enter the interface shown below.

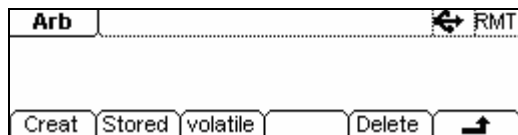

Figure 2-31 Operation Menu

Table 2-11 Waveform Edition Operation Menu

Function Menu	Settings	Explanation
Creat		Create a new waveform, and erase the waveform in the Volatile memory.
Stored		Edit the waveform stored in the non-Volatile memory
Volatile		Edit the waveform stored in the Volatile memory
Delete		Delete one of the Arbitrary Waveforms stored in the Non-volatile memory. But The five Built-in Waveforms can not be deleted.

Instructions:

1. When there is no waveform stored in the Non-Volatile Memory, the **Stored** Menu and the **Delete** Menu will hide.
2. When there is no waveform in the Volatile Memory, the **Volatile** menu will hide.

1. To Create a New Waveform

Press **Arb** → **Edit** → **Create**, to set the overall parameters for the waveform.
The setting interface is shown in Figure 2-32 and the menu in Table 2-12.

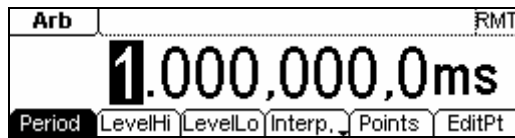

Figure 2-32

Interface for setting the new waveform parameters

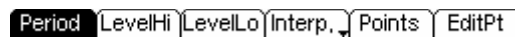

Figure 2-33 Operation Menu

Table 2-12 Setting the parameters for the new waveform

Function Menu	Settings	Explanation
Period		Setting the Period for the Waveform
LevelHi		Setting the Level High for the Waveform
LevelLo		Setting the Level Low for the Waveform
Interp On/ Off		Activate the linear Interpolation between the defined points Deactivate the linear Interpolation between the defined points
Points		Set the number of points when Initializing the waveform
EditPt		Start the Waveform Editor

To Set the Point Number

Press **Points**, set the number of the initializing points.

When a new waveform is created, the waveform editor will firstly create a waveform with two points. The Waveform Editor connects the last point to the Voltage Level of point #1 to create a continuous waveform automatically. A waveform with at most 4K points can be created.

In the default setting, point #1 is Level High, fixed on 0 second, while point #2 is Level Low and on the half of the set Cycle period.

To Set the Interpolation

Press **Interp**, if you choose **Interpolation On**, and the points will be connected with beelines; otherwise, the voltages between the two consecutive points will not change, and the waveform looks like a step-up one.

To Edit the Waveform Points

Press **Arb** → **Edit** → **Creat** → **EditPt**, The waveform can be defined by setting the time and voltage for each point using this function. The interface is as follows:

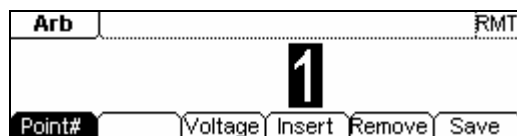

Figure 2-34 Operation Menu

Table 2-13 Waveform Parameter Edition Menu

Function Menu	Settings	Explanation
Point#		Select the point to be edited
Time		Set time for the Selected point
Voltage		Set Voltage for the Selected point
Insert		Insert a new point between the defined points. Use the "Time" and "Voltage" to define the new point.
Remove		Remove the current point
Save		Save the created waveform to the non-Volatile Memory.

Instruction:

The time for the last definable point should be less than the cycle period in the waveform.

Save the Waveform to the Non-Volatile Memory

Press **Arb** → **Edit** → **Creat** → **EditPt** → **Save**, enter the following interface. Select the desired waveform document to be saved, which will be displayed in inverse color and press **Save** to save it to the specific place.



Figure 2-35 Operation Menu

Table 2-14 Save New Waveform Menu

Function Menu	Settings	Explanation
Disk	Local	Choose display path for the system information
	U Disk (When a U disk is connected)	
Type	State	Setting of the Generator
	Data	Arbitrary waveform file
	All	All types of documentation
Recall		Recall the waveform or Setting information in the specified position in the memory.
Store		Save the waveform to the appointed place
Remove		Remove any waveform that has been stored in the memory

Instruction

To save the Arbitrary Waveform:

In the Non-volatile Memory, each waveform storage place can only save one waveform. If a new one is stored, the old one will be erased.

In the Graph Mode, the waveform is shown in Figure 2-36.

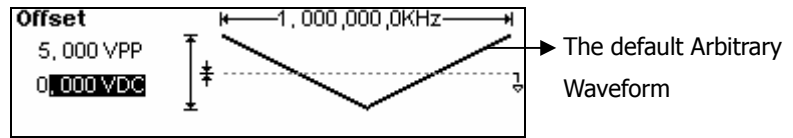

Figure 2-36
Waveform Parameter in the Graph Mode

2. To Edit the Stored Waveform

Press **Arb** → **Edit** → **Stored**, enter the following interface. Select the desired waveform document to be edited, which will be displayed in inverse color and press **Recall** to recall and edit it in the Volatile memory.



Figure 2-37 Operation Menu

Table 2-15 Edit Stored Waveform Menu

Function Menu	Settings	Explanation
Disk	Local	Choose display path for the system information
	U Disk (When a U disk is connected)	
Type	State	Setting of the Generator
	Data	Arbitrary waveform file
	All	All types of documentation
Recall		Recall the waveform or Setting information in the specified position in the memory.
Store		Save the waveform to the appointed place.
Remove		Remove any waveform that has been stored in the memory

3. To Delete a Waveform

Press **Arb** → **Edit** → **Delete**, to delete a waveform. Select the desired waveform to be deleted which will be displayed in inverse color and press **Remove** to delete it.

To Set Counter

Press **Count**, in the normal mode, the screen display the operation menu of the counter, see figure 2-38. Press “**Freq**”, “**Period**”, “**DutyCyc**”, “**PWidth**” and “**NWidth**”, the instrument will display measurement values of the frequency, period, duty cycle, positive width and negative width. Press **Setup** to set the measurement parameters.

To set measurement parameters of the counter containing: AC or DC, sensitivity, Trig Level, High frequency on or off. Different settings make different measurement results.

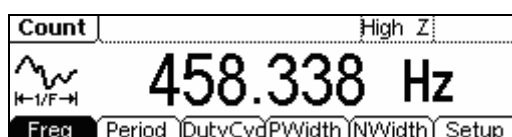

Figure 2-38
Normal display interface of the counter

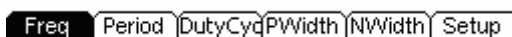

Figure 2-39 Operation menu

Table 2-16 Operation menu of the counter

Function menu	Settings	Explanation
Freq		Display the frequency of the signal to be measure
Period		Display the period of the signal to be measure
DutyCyc		Display the duty cycle of the signal to be measure
PWidth		Display the positive width of the signal to be measure
NWidth		Display the negative width of the signal to be measure
Setup		To set the measurement parameters of the counter (Coupling way, sensitivity, trig level)

To set the Auto measure

The counter can automatically detect signal with amplitude from 200mV_{PP} to 5V_{PP} and frequency form 1Hz to 200MHz. If there is signal that meet the request, press **Trig/Run**, it will automatically set the parameters of trig level, the sensitivity and the high frequency to be on or off.

To set the coupling mode

Press **Count** → **Setup** → **DC/AC**, to set the coupling mode.

See figure 2-40, the soft key with "DC" or "AC" is the current coupling mode, each time you press the key, the coupling mode will change. For example, the current mode is "AC", press the key, then the mode will be "DC".



Figure 2-40
To set the coupling mode

To set the sensitivity

The Sensitivity has three kinds: High, Medium and Low.

Press **Count** → **Setup** → **Sensitivity**, to set the sensitivity. Both display on the left of the screen or in grounding dark color key are the current sensitivity. Press the corresponding soft key to switch the sensitivity.

For example, the current sensitivity is "Low", press "High" to switch to be "high", see figure 2-41.

Suggest: For low amplitude signal, the "medium" or "high" sensitivity should be used. and for low frequency signal with high amplitude and slower rising edge, low sensitivity is a better choice.



Figure 2-41 To set the sensitivity

To set the Trig Level

The trig level (-3V~+3V) is divided into share, each "0.1" is 6 mV, it means the adjustment interval is 6 mV. For example, the input is "62.0", then the trig level is set to be : $-3V + (62.0 / 0.1) \times 6 \text{ mV} = 0.72V$.

(1) Press **Count** → **Setup** → **TrigLev**, to set the trig level.

The trig level display on the screen is the default value when power on or the value set at the last time. If the current value is effective, it could be use immediately.

(2) Input the required trig level.

Use the digits keyboard of the knob, input the required parameter, the counter will immediately adjust the trig level, and trigger according to the specified value.



Figure 2-42 To set the trig level

Note: In the DC coupling mode, users are need to adjust the trig level manually.

To set the High Frequency Restrain On/Off

High frequency restrain is used for filtering the high frequency signal in measuring the low frequency signal, and improve the measure accuracy.

Press **Count** → **Setup** → **HFR On/Off**, to set the high frequency restrain to be on or off.

See figure 2-43, the soft key of "HFR On" or "HFR Off" is the current state, each time you press the key, the state will change to another one.



Figure 2-43

To set the high frequency on/off

Suggest: To measure low frequency signal lower than 1kHz, you should put on the high frequency restrain to filter the high frequency noise disturb. To measure high frequency signal higher than 1kHz, you should put off the high frequency restrain.

To Generate the Modulated Waveform

Use the **Mod** button to generate modulated waveform. DG1000 Series can generate AM, FM, FSK, PM modulated waveforms. The modulation parameters should be set in different types of modulation. For example, In AM, users can set the Source (Internal/ External), depth, Modulating Frequency, Modulating Waveform and Carrier Waveform; in FM, users can set the Source (Internal/ External), Frequency Deviation, Modulating Waveform and Carrier Waveform; in FSK, users can set the Source (Internal/ External), Frequency Range, Internal Rate, Modulating Waveform and Carrier Waveform; while in PM, users can set the Source (Internal/ External), Phase Deviation, Modulating Frequency, Modulating Waveform and Carrier Waveform, etc.

We will explain how to set these parameters in details according to different types of modulation.



Figure 2-44
Modulated Waveform Parameters Interface

AM

The modulated waveform consists of two parts: the Carrier Waveform and the Modulating Waveform. In AM, the Amplitude of the Carrier Waveform varies with the instantaneous voltage of the modulating waveform. The Parameters for the AM are in Table 2-17.



Figure 2-45
Modulated Waveform Parameters Interface for AM

Press **Mod** → **Type** → **AM**, enter the following interface.

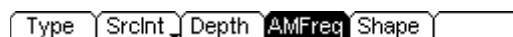

Figure 2-46 Operation Menu

Table 2-17 Setting the AM parameters

Function Menu	Settings	Explanation
Type	AM	Amplitude Modulation
SrcInt SrcExt	Internal	The Source is Internal
	External	The Source is External, use the [Modulation In] connector in the Rear panel.
Depth		Set the amplitude range
AMFreq		Set the modulating waveform frequency. Frequency Range: 2mHz~20kHz (Only Internal).
Shape	Sine Square Triangle UpRamp DnRamp Noise Arb	Choose the modulating Waveform. To change the Carrier Waveform parameter, press Sine , Square etc.

In the Graph Mode, the waveform is shown in Figure 2-47.

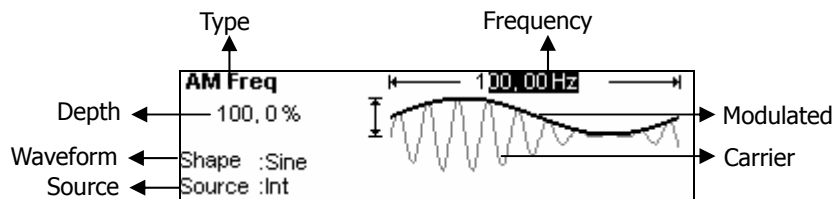

Figure 2-47 Waveform Parameter in the Graph Mode

Term Explanation

Modulation Depth

The Amplitude Range (also called "percentage Modulation"). Modulation Depth varies from 0% to 120%.

1. In the 0% Modulation, the output amplitude is the half of the set one.
2. In the 100% Modulation, the output amplitude is the same with the set one.
3. When the modulation is greater than 100%, the instrument output no greater than 10 V_{PP}. For an external source, the depth of AM is controlled by the voltage level of the connector connected to the [Modulation In]. +5V corresponds to the currently set depth.

FM

The modulated waveform consists of two parts: the Carrier Waveform and the Modulating Waveform. In FM, the Frequency of the Carrier Waveform varies with the instantaneous voltage of the modulating waveform. The Parameters for the FM are as shown in Figure 2-49.



Figure 2-48
FM Waveform Parameter Setting Interface

Press **Mod** → **Type** → **FM**, enter the following interface.



Figure 2-49 Operation Menu

Table 2-18 Setting the FM parameters

Function Menu	Settings	Explanation
Type	FM	Frequency Modulation
SrcInt SrcExt	Internal	Choose the Internal source.
	external	Use the rear [Modulation In] linker to choose the external source.
Deviat.		Set the Frequency Deviation between the Modulating Waveform and the Carrier Waveform.
FMFreq		Set the modulating waveform frequency. Frequency Range: 2mHz~20kHz (Internal Source Only).
Shape	Sine Square Triangle UpRamp DnRamp Noise Arb	Press the function key Sine , Square etc. to choose different Shape of waveform.

In the Graph Mode, the waveform is shown in Figure 2-50.

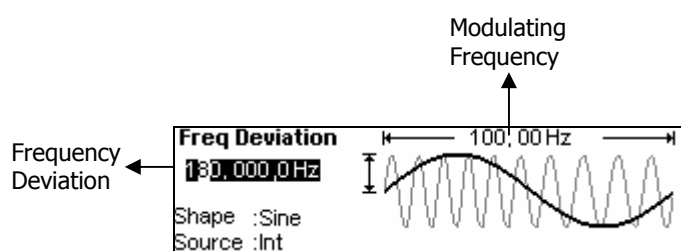

Figure 2-50
Waveform Parameter in the Graph Mode

Term Explanation

Frequency Deviation

1. The Deviation should be equal to or less than the Carrier Waveform Frequency.
2. The Sum of the Deviation and the Carrier Frequency should be equal to or less than maximum frequency of the selected function plus 100 kHz.
3. For an External Source, the Deviation is controlled by the $\pm 5V$ voltage Level of the Connector connected to the [Modulation In]. +5V corresponds to the selected Deviation. Lower external voltage generates less deviation, while negative voltage reduces the modulated signal frequency to below the corresponding carrier's.

FSK

The FSK Modulation is a modulation method, the output frequency of which switches between the two pre-set frequencies (Carrier Waveform Frequency and the Hop Frequency). The Frequency for the Output Frequency to switch from the carrier waveform frequency to and from the Hop frequency is called the FSK rate. The frequency by which the output frequency switch from each other is determined by the Internal Frequency generator or the Signal Voltage Level offered by the [Trig In] connector on the rear panel:

- If you choose the Internal Modulation, the frequency at which the output frequency shift between the carrier frequency and the Hop frequency is determined by the set FSK rate.
- If you choose External Modulation and overlook the FSK rate, the output frequency is determined by the Voltage Level of the [Trig In] connector on the rear panel. If the Voltage Level is Low, then generate the carrier frequency; when the voltage level is high, generate the Hop frequency.



Figure 2-51

FSK Waveform Parameter Setting Interface

Press **Mod** → **Type** → **FSK**, enter the following interface.



Figure 2-52 Operation Menu

Table 2-19 Setting the FM parameters

Function Menu	Settings	Explanation
Type	FSK	Frequency Shift Keying Modulation
SrcInt SrcExt	Internal	Choose the Internal source.
	external	Use the rear [Modulation In] linker to choose the external source.
HopFreq		Set the Hop Frequency Range: 1μHz~8MHz
FSK Rate		Set the frequency at which the output frequency shifts between the carrier frequency and the jumping frequency (Internal Modulation Only): 2mHz~50kHz.

In the Graph Mode, the waveform is shown in Figure 2-53.

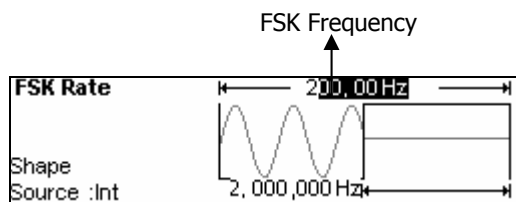

Figure 2-53
Waveform Parameter in the Graph Mode

PM

The modulated waveform consists of two parts: the Carrier Waveform and the Modulating Waveform. In PM, the Phase of the Carrier Waveform varies with the instantaneous voltage Level of the modulating waveform. The Parameters for the PM are as shown in Figure 2-55.



Figure 2-54

PM Waveform Parameter Setting Interface

Press **Mod** → **Type** → **PM**, enter the following interface.



Figure 2-55 Operation Menu

Table 2-20 Setting the PM parameters

Function Menu	Settings	Explanation
Type	PM	Phase Modulation
SrcInt SrcExt	Internal	Choose the Internal source.
	external	Use the rear [Modulation In] linker to choose the external source.
Deviat.		Set the Phase Deviation between the Modulating Waveform and the Carrier Waveform, ranging from 0° to 360°
Freq		Set the modulating waveform frequency. Frequency Range: 2mHz~20kHz (Internal source Only).
Shape	Sine Square Triangle UpRamp DnRamp Noise Arb	Press the function key Sine 、 Square etc. to choose different Shape of waveform.

In the Graph Mode, the waveform is shown in Figure 2-56.

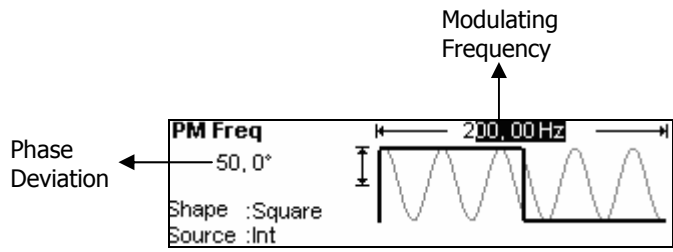

Figure 2-56
Waveform Parameter in the Graph Mode

To Generate Sweep

In the frequency sweep mode, the function generator “sweep” from the start frequency to the stop frequency at the sweep rate you specify. Sweeping can be generated by Sine, Square, Ramp or Arbitrary Waveforms (Pulse, Noise and DC are not allowed).

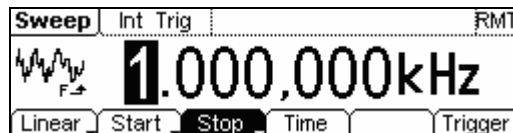

Figure 2-57

Sweep Waveform Parameter Setting Interface

Press **Sweep** button, in the Normal Mode, the operation menu will appear on the bottom of the screen, see Figure 2-58. Set the Waveform parameters by using the operation menu.



Figure 2-58

Operation Menu

Table 2-21 Waveform Sweep Setting Menu

Function Menu	Settings	Explanation
Linear log		Set the Sweep with linear spacing Set the Sweep with logarithmic spacing
Start Center		Set the Start Frequency of the Sweep Set the Center Frequency of the Sweep
Stop Span		Set the Stop Frequency of the Sweep Set the Frequency Span of the Sweep
Time		Set the Time Span of the Sweep for which the Frequency changes from the Start Frequency to Stop Frequency.
Trigger	Source	Int: Choose Internal Source Ext: Choose External Source, use the [Modulation In] connector in the rear panel Manual: Choose External Source, set the start and stop time by hand
	TrigOut	⬆: Signal Triggered at Rise Edge ⬇: Signal Triggered at Fall Edge Off: Turn off Trigger Setting
	↩	Finish Setting

Sweep Frequency Setting

Use **Start** and **Stop** or **Center** and **Span** to set the range of the frequency. Press the button again to switch to each other.

- To Sweep upward, set the Start Frequency lower than the Stop Frequency, or set a positive frequency interval.
- To Sweep downward, set the Start Frequency higher than the Stop Frequency, or set a negative frequency interval.

To Generate Burst

Burst Function can generate versatile waveforms in burst, which can last specific times of waveform cycle(N-Cycle Burst), or when the external gated signals(Gated Burst) is applied, any waveform could be used, but noise can only be used in Gated Burst.

Press **Burst** button, in the Normal Mode, the operation menu will appear on the screen, see Figure 2-59. Set the Waveform parameters by using the operation menu.

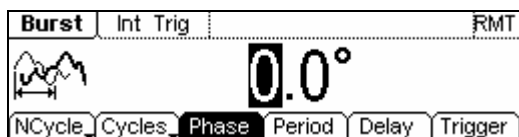

Figure 2-59
Burst Waveform Parameter Setting Interface

Set the N-Cycle Burst

Press **Burst** → **NCycle**, enter the following interface.

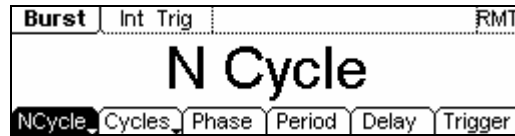

Figure 2-60 Operation Menu

Table 2-22 Setting the N-Cycle parameters

Function Menu	Settings	Explanation
N-Cycle Gated		Use the N-Cycle Mode Use the Gated Mode
Cycles Infinite		Set the Number of the bursts in a N-Cycle Set the Number of the bursts in a N-Cycle to be infinite
Phase		Set the Start Phase of the Burst
Period		Set the Period of the Burst
Delay		Set the Delay for the burst
Trigger	Source	Int: Choose Internal Source Ext: Choose External Source, use the [Modulation In] connector in the rear panel Manual: Choose External Source, set the start and stop time by hand
	TrigOut	↑ : Signal Triggered at Rise Edge ↓ : Signal Triggered at Fall Edge Off: Turn off Trigger Setting
	↗	Finish Setting

N-Cycle/ Gated

N-Cycle has specific number of waveform cycles, and every burst is activated by a trigger event. Gated burst use external source to control burst when to be activated.

Cycle Number

Set the number of Waveform Cycle in an N-Cycle (1 to 50,000 or Infinite).

If you choose Infinite, then a continuous waveform will be generate which will not stop until a trigger event happens (Trig/Run button is pressed).

- If needed, Burst Period will increase to cater to the specific number of cycles.
- For an infinite-cycle Burst, External or Manual Trigger is needed to activate burst.

Phase

Define the Start and the Stop Point in a waveform. The phase varies from -360° to $+360^\circ$, and the default setting is 0° . For an Arbitrary Waveform, 0° is the phase of the first waveform point.

Period

Set the time span between an N-Cycle Burst to the next. If necessary the period will increase to allow the specific number of cycles in a burst.

Burst Period > Period X Burst Number

Delay

Set the Time Delay between the Trigger Input and the Start of the N-Cycle Burst. The minimum delay is a function of the specific burst period, and should always be greater than 0.

In the Graph Mode, the waveform is shown in Figure 2-61.

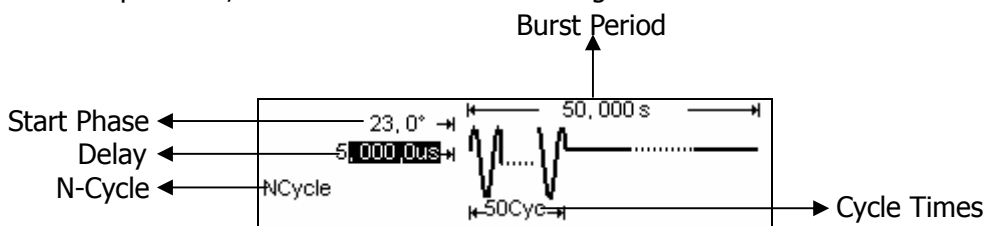

Figure 2-61
Waveform Parameter in the Graph Mode

Set the Gated Burst

Press **Burst** → **Gated**, enter the following interface.



Figure 2-62 Operation Menu

Table 2-23 Setting the Gated parameters

Function Menu	Settings	Explanation
NCycle Gated		Set the Gated Mode
Polarity	Pos Neg	Set the Polarity for the Gated Signal
Phase		Set the Start Phase for the Gated Signal

In the Graph Mode, the waveform is shown in Figure 2-63.

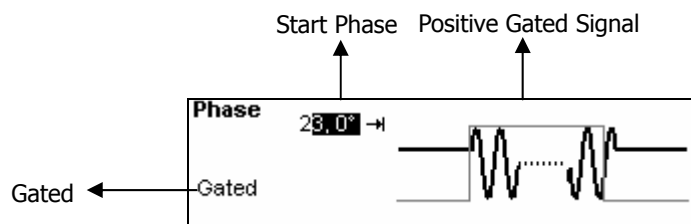

Figure 2-63

Waveform Parameter in the Graph Mode

To Store and Recall

Press **Store/Recall** Button, and the operation menu will appear at the bottom of the screen. You can save or read the State or Data Documentation inside the Generator or build and delete documentation in the U Disk. File names can either be Chinese or English.



Figure 2-64 Save and Read Interface

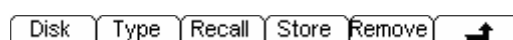

Figure 2-65 Operation Menu

Table 2-24 Save and Read Menu

Function Menu	Settings	Explanation
Disk	Local	Choose display route for the system information
	U Disk (When U Disk is connected)	
Type	State	Setting of the Generator
	Data	Arbitrary waveform file
	All	All types of documentation
Recall		Recall the waveform or Setting information in the specific position in the memory.
Store		Save the waveform to the appointed place.
Remove		Remove any waveform that has been stored in the memory

About the Disk

Use the **Disk** button to choose Local or U Disk (When U Disk is connected).

To Save the Instrument State

Users are allowed to store the instrument state on any of the 4 Non-Volatile Memories. When the power is restored, the instrument will return to the state when it is powered off automatically. The state storage will “memorize” the selected function (including the Arbitrary Waveform), Frequency, Amplitude, DC Offset, Duty Cycle, Symmetry, and other modulation parameter used.

To Save the Instrument State, following the steps:

- (1) Choose the file Type to store

Press **Store/Recall** → **State**, and choose the storage type to be “State”.

- (2) Choose the location of the file.

There are four positions in the Local STATE1, STATE2, STATE3 and STATE4, choose one of them by rotating the knob.

- (3) Name the file and Save it

Press **Store** button, enter the desired name. Press **Store** to finish.

To Save Data

Users are allowed to store data document on any of the 4 Non-Volatile Memories. If the place is already occupied, the new document will cover the old one. To save the data, following the steps:

- (1) Choose the file Type to store
Press **Store/Recall** → **State** → **data**, and choose "data" as the storage type.
- (2) Choose the location of the file.
There are four positions in the Local ARB1, ARB2, ARB3 and ARB4, choose one of them by rotating the knob.
- (3) Name the file and Save
Press **Store** button, enter the desired name. Press **Store** to finish.

To Use USB storage

As shown in figure 2-66, the storage location is divided into: the inherent Local storage and the U Disk storage. At the left side of the front panel, there is a USB interface. When USB storage is connected, the storage menu will show "U Disk". Otherwise, the default location is the internal location Local.



Figure 2-66 To use the USB Storage

(1) Install the mobile Storage

Insert the mobile memory to the USB interface on the front panel, and the screen will show "⚡".

(2) Choose the mobile memory

Press **Disk**, move the cursor upward or downward to select "U Disk". Choose **Type** to be "data" and press **Store**, enter the file name and then press **Store** to save the file.

(3) Uninstall the mobile Storage

Remove the U Disk from the Interface and the system will inform you that the U Disk has been removed, and the "⚡" Sign will disappear.

To Save a File

Press **Store/Recall** → **Store**, enter the following interface. Enter the desired file name in the "File Name" frame. Under the frame is the input keypad. Use the direction button to select the desired character. When the character is in inverse color, press **Select** to input it.



Figure 2-67 File Storage Interface

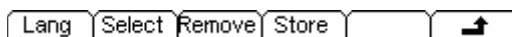

Figure 2-68 Operation Menu

Table 2-25 File Storage Menu

Function Menu	Settings	Explanation
Lang	EN	English Input
	CN	Chinese Input
Select		Select the current character
Remove		Delete the current character
Store		Store the file with the current name
↵		Cancel the current operation

1. English Input

The English Input Interface is shown in Figure 2-69, to save a file named as "NewFile", following the steps below:

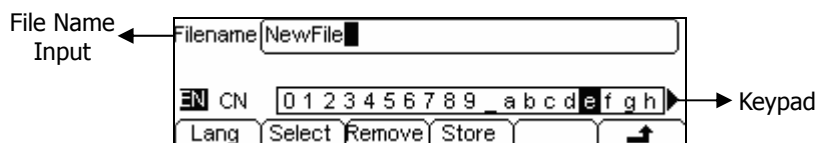

Figure 2-69 English Input Interface

- (1) Press **Lang** → **EN**, enter the English Interface.
- (2) Input the file name "NewFile".
Use the Knob to adjust the cursor to the right character, and press **Select**. Repeat this until you have selected all the characters needed. Press **+/-** to choose the majuscule or lowercase.
- (3) Edit the File Name
When you have entered a wrong character, move the cursor to the wrong character and press **Remove** to delete it. And then enter the file name again.
- (4) Press **Store**, to finish and save the file.

2. Chinese Input

The Chinese Input Interface is shown in figure 2-70. To save a new file, follow the instructions below:



Figure 2-70 Chinese Input Interface

- (1) Press **Lang** → **CN**, enter the Chinese Input Interface.
- (2) Press "+/-" to choose the lowercase, and input the spell of the Chinese.
- (3) Input the file name: "新文件"
Use the Knob to adjust the cursor to the right character, and press **Select**. Input "Xin". In the Input Menu, choose the Chinese character you need with the help of the page controller and the 1~9 button on the keypad.
- (4) Edit the wrong input
When a file name is wrong, move the cursor to the character and press **Remove** to delete it and enter the file name again.
- (5) Press **Store** to finish and save the file.

To Set the Utility Function

With the **Utility** Function, you can set the parameters of the Generator such as: DC On/Off, Sync On/Off, Output Parameter, Interface Parameter, System Setting and Testing Parameter. The DC switch offers the options of DC output or Arbitrary Waveform Output. Sync Switch offers the option to choose the Sync Signal or not. The output Setting provides the parameter setting for Load/Impedance, Range, Normal/ Inverse and Phase. The interface Setting offers the storage and load of the configure parameter setting for USB remote Control. The System Setting provides the setting for Language, Display, Beep, Screen Guard, Format, Power System Configure and default setting; the test provides the self-testing and calibration storage as well as the password and safety switch.

Press **Utility** to enter the Utility Menu. Its functions are listed below in table 2-26.

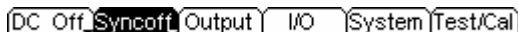

Figure 2-71 Operation Menu

Table 2-26 Utility System Setting

Function Menu	Settings	Explanation
DC On Off	On	Set the output waveform to be DC
	Off	Set the output waveform to be Arbitrary.
Sync On Sync Off	On	Activate the Sync Signal on the [Sync] Connector on the front panel.
	Off	Deactivate the Sync Signal on the [Sync] Connector on the front panel.
Output		Set the Output parameter
I/O		Set the I/O
System		Set the System Configuration
Test/Cal		Test and Calibrate the instrument

Instruction**Sync Switch Setting:**

When the amplitude is low relatively, you can reduce the distortion when output the signal by prohibiting the Sync Signal. And the current storage is in the Non-Volatile Memory.

To Set the DC Output

Press **Utility** → **DC On/Off** → **DC On**, enter the following interface.



Figure 2-72 The DC Setting Interface

DC Offset

Set the DC Voltage Level.

To Shift into the Arbitrary Waveform Output

- (1) Press **Utility** → **DC On/Off** → **DC Off**, close the DC output and return the output of the Arbitrary Waveform.
- (2) Press any functional button, and the waveform output setting turns to the output of arbitrary waveform. The DC option is turned off automatically.

In the Graph Mode, the waveform is shown in Figure 2-73.

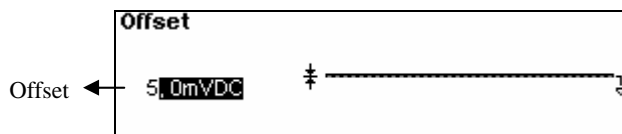

Figure 2-73
Waveform Parameter in the Graph Mode

To Set the Sync Output

The Generator provides Sync output through the [Sync/Counter] Connector on the Front Panel. All the standard output functions (except DC and Noise) have a corresponding Sync Signal. For some Sync applications, they can be prohibited if users do not want to use them.

- In the default setting, the Sync Signal output is disabled, the output Voltage of the [Sync/Counter] Connector Level is Low.
- In the Inverse Mode, the Waveform that corresponds to the Sync Signal does not Inverse.
- If frequency of the standard output function (except DC and Noise) is higher than 2MHz, the Sync output will automatically put off.
- For Sine, Square and Pulse Signal, the Sync Signal is a Square Signal with 50% Duty Cycle. When the output is positive, The Sync Signal is TTL Level High compared to 0 V Voltage or DC Offset; when the output is negative, The Sync Signal is TTL Level Low compared to 0 V Voltage or DC Offset.
- For Square Waves, the Sync Signal is a Square Wave with the same Duty Cycle with the main output Square Wave. When the Output is positive, The Sync Signal is TTL Level High compared to 0 V Voltage or DC Offset; when the output is negative, The Sync Signal is TTL Level Low compared to 0 V Voltage or DC Offset.
- For Arbitrary Waveform, the Sync Signal is a Square Waveform with 50% Duty Cycle. At the time when the first output waveform point is generated, the Sync Signal Voltage is TTL Level High.
- For the internal Modulating of AM, FM and PM, the Sync Signal reference is the Modulated Signal (not the Carrier Signal). The Sync Signal is a Square Waveform with 50% Duty Cycle. In the first half modulation period, the Sync Signal is TTL Level High. For External Modulation, the Sync Signal reference is the Carrier Signal (not the Modulated Signal). The Sync Signal is also a Square Waveform with 50% Duty Cycle.

- For FSK, the Sync Signal Reference is the Hop Frequency, and the Sync Signal is a Square Waveform with 50% Duty Cycle. For the Hop Frequency, at the hopping point, the Sync Signal is TTL Level High.
- For the Burst, when the burst starts, the Sync Signal is Level High. At the specific point when the Cycle Number ends, the Sync Signal turns Level Low (If the Waveform has a relative starting phase, then intersections may occur). For an infinite burst, the Sync Signal is the same as the Sync Signal of the continuous Signal.
- For the External Gated Burst, the Sync Signal follows the External Gated Signal. But, please note that this signal will not turn Level Low until the last period end (If the Waveform has a relative starting phase, it may be not intersections).

To Set Output Parameter

Press **Utility** → **Output**, enter the following interface.



Figure 2-74 Operation Menu

Table 2-27 Operation Setting Menu

Function Menu	Settings	Explanation
Load High Z		Set the Load connected to the Output Connector.
		Set the Load connected to the Output Connector to be High Z.
Range	Auto	Allow the Instrument to choose the best Amplifier/ Attenuator
	Hold	Disable the Auto Adjusting
Normal Inverse		Normal Output Inverse Output
Phase		Set the Phase Offset of the Output Waveform

Instruction

Hold Range

Select **Hold**, prohibit the auto optimizing. This will eliminate the "burr" caused by the switch of the Attenuator. But, the precision and the resolution (the fidelity of the original waveform) may be affected.

1. To Set the Output Load

For the [Output] Connector on the Front panel, the Generator has a built-in 50Ω series output impedance. If the actual load does not match the set one, the amplitude and offset displayed are incorrect. This function is used to match the displayed voltage with the expected one.

Steps for setting the Load value:

- (1) Press **Utility** → **Output** → **Load**, enter the following interface.

Please note that the Load Parameter shown on the right bottom is the default setting when the power is on or the pre-set load value. If the current value is valid for the output, then the current value can be used.

- (2) Input the desired Load Value.

Use the Keypad or the Knob to enter the desired value and choose the unit, Ω or $K\Omega$, press the corresponding button.

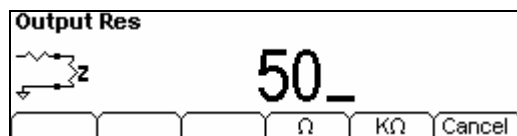

Figure 2-75 Set the Output Load

Instruction

DG1000 Series have a fixed 50Ω Series impedance no matter what value has been set for this parameter.

If the real load is different from the set one, the displayed voltage will not equal to the real voltage.

2. To Set the Inverse Waveform

Press **Utility** → **Output** → **Inverse**, to set the inverse Waveform output.

No offset voltage will change while the waveform is inversed. An inverse waveform will be displayed in the Graph Mode.

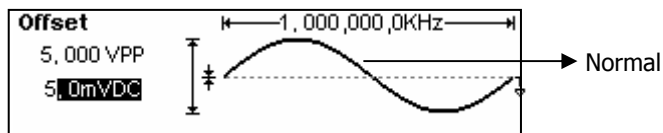

Figure 2-76 Normal Waveform

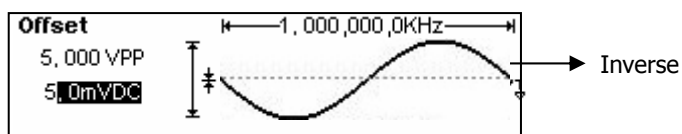

Figure 2-77 Inverse Waveform

3. To Adjust the Phase

Press **Utility** → **Output** → **Phase**, enter the following interface.

Set the Phase use the unit of degree.

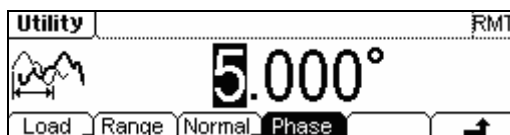

Figure 2-78 Setting the Phase

To Set the I/O

Press **Utility** → **I/O**, to set the I/O. See Figure 2-79.

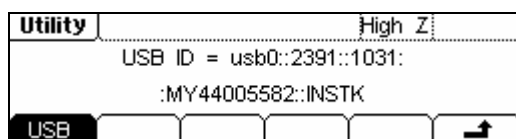

Figure 2-79 Operation Menu

Table 2-28 I/O Setting Menu

Function Menu	Settings	Explanation
USB		USB ID=usb0::2391::1031::MY44005582::INSTK

To Set the System

Press **Utility** → **System**, enter the following interface.

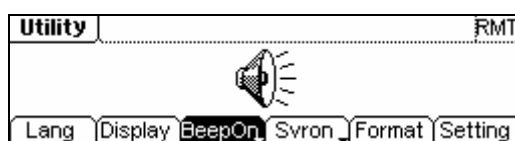

Figure 2-80
Operation Menu

Table 2-29 System Setting Menu

Function Menu	Settings	Explanation
Lang		Set the Display Language
Display		Set the parameter for the Screen Display
Beep On/Off	On	Open Beep
	Off	Close Beep
Svr on/off	On	Activate the Screen Guard Program. Screen Guard will be on if no action is taken within 3 minutes. Press any button the resume.
	Off	deactivate the Screen Guard Program
Format		Set the data format
Setting	PowOn	Default: When the power is on, all the setting will return to the default value. Latest: When the power is on, all the setting will return to the latest setting.
	Default	Return all the setting into the default one
	Timer	Choose the clock source as: internal/external

Key points:

Power On

The Setting is used when the machine is power on.

Two choices are available: the default setting and the latest. Once selected, the setting will be used when the instrument is restarted.

Beep

Activate or deactivate the sound when an error occurs from the front panel or the remote interface. Activate or deactivate any sound made by the button or knob on the front panel.

1. Language Setting

The DG1000 Series Generator offers two languages: Chinese and English. To Select Language, press **Utility** and then **Lang** to select the language.

Press **Utility** → **System** → **Lang**, change the language.



Figure 2-81 Language Setting Menu

2. Display Control

Press **Utility** → **System** → **Display**, enter the following menu.

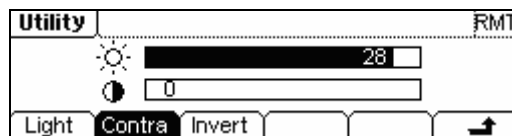

Figure 2-82 Operation Menu

Table 2-30 Display Parameter Setting

Function Menu	Settings	Explanation
Contra		Set the Display Contrast Parameter
Light		Set the Display Light Parameter
Invert		Set the Invert Display

3. Set the Format

Press **Utility** → **System** → **Format**, enter the following interface.

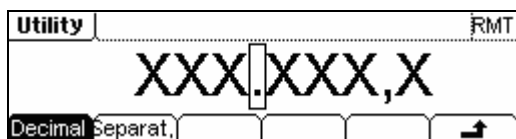

Figure 2-83 Setting the data Format

Table 2-31 Setting the Data Format

Function Menu	Settings	Explanation
Decimal	•	Using dot
	,	Using comma
Separat.	No	Close the Separate.
	Space	Use Space to separate
	On	Enable the Separate

According to the different choice of the decimal and the separate, the format can have various forms:

(1) “•” as decimal, press **Separat.** → **On**, the example is as follows:

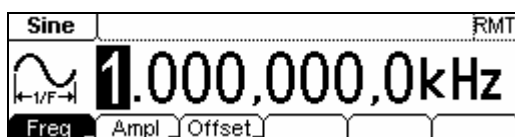

Figure 2-84 Setting the data format

(2) “,” as decimal, press **Separat.** → **On**, the example is as follows:

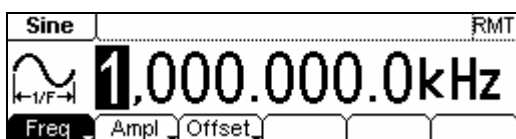

Figure 2-85 Setting the data format

- (3) "." as decimal, press **Separat.** → **No**, the example is as follows:

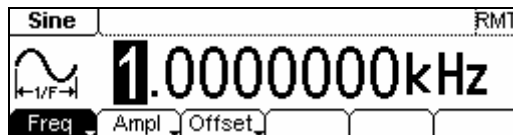

Figure 2-86 Setting the data format

- (4) "," as decimal, press **Separat.** → **No**, the example is as follows:

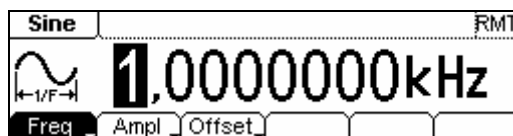

Figure 2-87 Setting the data format

- (5) "." as decimal, press **Separat.** → **Space**, the example is as follows:

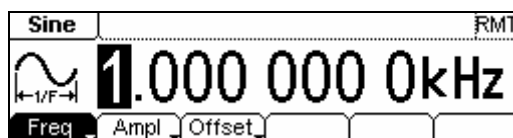

Figure 2-88 Setting the data format

- (6) "," as decimal, press **Separat.** → **Space**, the example is as follows:

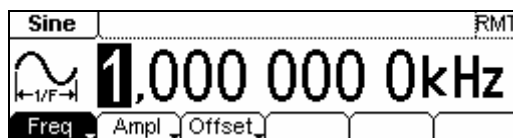

Figure 2-89 Setting the data format

4. To Return to Default Setting

Press **Utility** → **System** → **Setting** → **Default**, return the default setting of the system:

Table 2-32 Default Parameter Setting

Output	Default
Function	Sine Wave
Frequency	1kHz
Amplitude/Offset	5 V _{PP} /0.000 V _{DC}
Unit	V _{PP}
Terminals	High Z
Auto Adjustment	On

Modulation	Default
Carrier	1kHz Sine Wave
Modulating	100Hz Sine Wave
AM Depth	100%
FM Deviation	100Hz
FSK Hop Frequency	10Hz
FSK Frequency	100Hz
Modulation State	Off

Sweep	Default
Start/Stop Frequency	100Hz/1kHz
Time	1s
Mode	Linear
State	Off

Burst	Default
Frequency	1kHz
Count	1Cycle

Period	10ms
Phase	0°
State	Off

Count	Default
Coupling	AC
Sensitivity	High
Trig Lev	71.0 (1.26V)
HFR Off	Off

System	Default
*Power-down Recall	*Disabled
Display	On
Error Array	Clear Error
Storage State and any Waveform	No change
Output State	Off

Trigger	Default
Source	Internal

Calibration	Default
State	Coded

The parameter with an asterisk (*) is stored in the Non-Volatile Memory.

Test

Press **Utility** → **Test/Cal**, enter the following menu.



Figure 2-90 Test Menu



Figure 2-91 Operation Menu

Table 2-33 Test Setting Menu

Function Menu	Settings	Explanation
Test		Perform System Self-Test
Info		Show the information for Calibration times and other related ones
PassWd		Input the password for Secure calibration
Cal		Perform the Calibration
SecOn	On	Turn On Secure Setting, disables the calibration by anyone
SecOff	Off	Turn Off Secure Setting, enables the calibration by anyone

1. Test

Press **Utility** → **Test/Cal** → **Test**, to perform self-testing. When the instrument is powered, the system will perform the self-testing automatically. This limited test can test if the instrument could work ordinarily. To perform a general test needs 15 seconds. If all the tests have been passed, you can use the generator freely. If the general test has been passed, the screen will show "Self-Test Passed"; if not, it will also tell you self-test failed and display the error message.

2. Calibration

The information consist the calibration counting and the edition.

Please note that the generator has been calibrated before it leaved the factory, When you turn on a new instrument, the default number of the calibration is 0. You can get the information of the latest version on the company's website: <http://www.rigol.com>.

3. Password

This function is used to prevent unauthorized or accidental calibration to the generator. When the generator is firstly shipped to the user, it is secured. You have to unlock it before calibrating the instrument.

Press **Utility** → **Test/Cal** → **PassWd**, and enter the right password. The system will display "The System is now unsecured". **SecOff** will appear, see Figure 2-92, The default password is "**12345**". It is stored in the Non-Volatile Memory, and will not change when the instrument is powered off or the Remote I/O is reset.



Figure 2-92 Operation Menu

How to Use the Built-in Help System

You can get a particular help for every button on the front panel by using the built-in help system. Or you can get help about the operation of the front panel buttons with the Help List.

Press **Help** enter the following interface.

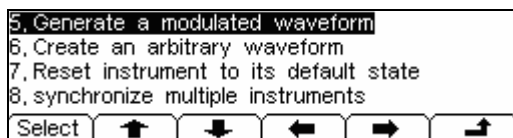

Figure 2-93 Help Menu

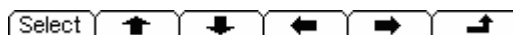

Figure 2-94 Operation Menu

Table 2-34 Help Menu

Function Menu	Settings	Explanation
Select		Select and read the Information
↑		Page Up
↓		Page Down
→		Cursor Downward to select
←		Cursor Upward to select
↗		Exit the help menu

1. View the last message display

View the last message display.

2. View the remote Command error queue

View the remote command error queue in the remote operation.

3. Get HELP on any key

To get context-sensitive help on any front-panel key or menu softkey, press and hold that key for a few times.

4. Generate a DC-only Voltage level

- (1) Press **Utility** and select **DC On**.
- (2) Press **Offset**, then enter the desired voltage level.
- (3) Choose **DC On/Off** → **DC Off**, or press any function key to resume the normal waveform operation.

5. Generate a modulated Waveform

- (1) Configure the Carrier waveform by selecting the waveform shapes, frequency, amplitude, etc.
- (2) Configure the modulating waveform by pressing the **Mod** key.
- (3) To change the Carrier parameter, press the lighted function key (**Sine** , **Square** etc).
- (4) To turn off the modulation, press the lighted **Mod** key.

6. Create an arbitrary waveform

- (1) Press **Arb** and choose **Edit**→ **Create**.
- (2) Enter the desired period, voltage limit, and the number of points and then press "Edit Pt", the first two points have defined for you.
- (3) Rotate the knob to select the desired point for editing and then use **Time** and **Voltage** to define the point. Press **Insert** to insert additional points as needed.
- (4) The waveform editor connects the last point to the voltage level of point #1 to create a continuous waveform. Make sure that the time value of the last point less than the specified period.
- (5) Press **Save** to store the waveform and exit the waveform editor.

7. Reset instrument to its default state

- (1) Press **Utility** to enter the utility function.
- (2) Choose **System** → **Setting**;
- (3) Select **Default** to reset the instrument as its default state.

8. Synchronize multiple instruments

By using the external I/O of the generator, connect the instrument to the other kinds of instruments, to perform the synchronous control.

9. RIGOL Technology Support

To obtain technical support, contract the local **RIGOL** Support Center or go to **RIGOL** website: www.rigol.com
Consult Chapter 5 for more details.

Chapter 3 Application & Examples

To help the users grasping how to use the Function/ Arbitrary Waveform Generator more efficiently, here we will give some examples in detail. All the examples given below use the default setting of the instrument.

Example 1: To Generate a Sine Wave

How to generate a Sine Waveform with 20 kHz frequency, 2.5 mV_{PP} Amplitude and 0 V_{DC} Offset.

The operation steps:

1. Set the Frequency.
 - (1) Press **Sine** → **Freq/Period** and choose **Freq** which will display in reverse color.
 - (2) Input "20" from the keypad and choose the unit "kHz". The Frequency is set to be 20 kHz.
2. Set the Amplitude.
 - (1) Press **Ampl/ HiLev** to choose **Ampl** which will display in reverse color.
 - (2) Enter "2.5" from the keypad and choose the unit "mV_{PP}". The Amplitude is set to be 2.5mV_{PP}.
3. Set the Offset.
 - (1) Press **Offset /LoLev** to choose **Offset** which will display in reverse color.
 - (2) Enter "0" from the keypad and choose the unit "V_{DC}"; The Offset is set to be 0 V_{DC}.

When the Frequency, Amplitude and Offset were set, the generated waveform is shown in Figure 3-1.

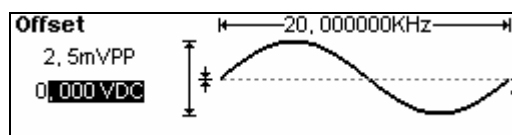

Figure 3-1 Sine Waveform Output

Example 2: To Generate a Square Wave

How to generate a Square waveform with 1MHz Frequency, 2.0 V_{PP} Amplitude, 10m V_{DC} Offset and 30% Duty Cycle.

The operation steps:

1. Set the Frequency.
 - (1) Press **Square** → **Freq/Period** and choose **Freq** which will display in reverse color.
 - (2) Input "1" from the keypad and choose the unit "MHz" to set the Frequency as 1MHz.
2. Set the Amplitude.
 - (1) Press **Ampl/ HiLev** and choose **Ampl** which will display in reverse color.
 - (2) Enter "2" from the keypad and choose the unit "V_{PP}" to set the Amplitude as 2 V_{PP}.
3. Set the Offset.
 - (1) Press **Offset /LoLev** to choose **Offset** which will display in reverse color.
 - (2) Enter "10" from the keypad and choose the unit "mV_{DC}" to set the Offset as 10m V_{DC}.
4. Set the Duty Cycle.
 - (1) Press **DtyCyc** which will display in reverse color.
 - (2) Enter "30" from the keypad and choose the unit "%" to set the Duty Cycle as 30%.

When the Frequency, Amplitude Offset and Duty Cycle were set, the generated waveform is shown in Figure 3-2.

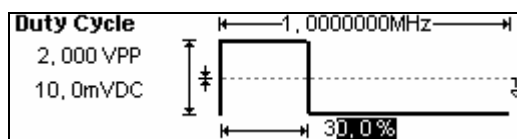

Figure 3-2 Square Waveform Output

Example 3: To Generate a Ramp Wave

How to generate a Ramp waveform with Period of 10ms, Amplitude of 100mV_{PP}, Offset of 20mV_{DC} and Symmetry of 80%.

The operation steps:

1. Set the Period.
 - (1) Press **Ramp** → **Freq/Period** and choose **Freq** which will display in reverse color.
 - (2) Input "10" from the keypad and choose the unit "s" to set the Period as 10ms.

2. Set the Amplitude.
 - (1) Press **Ampl/ HiLev** and choose **Ampl** which will display in reverse color.
 - (2) Enter "100" from the keypad and choose the unit "mV_{PP}" to set the Amplitude as 100mV_{PP}.

3. Set the Offset.
 - (1) Press **Offset /LoLev** to choose **Offset** which will display in reverse color.
 - (2) Enter "20" from the keypad and choose the unit "mV_{DC}" to set the Offset as 20mV_{DC}.

4. Set the Symmetry.
 - (1) Press **Symm** which will display in reverse color.
 - (2) Enter "80" from the keypad and choose the unit "%" to set the Symmetry as 80%.

When the Frequency, Amplitude Offset and Symmetry were set, the generated waveform is shown in Figure 3-3.

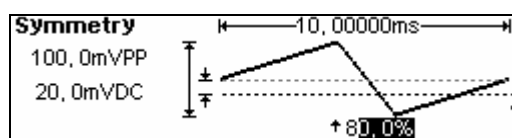

Figure 3-3 Ramp Waveform Output

Example 4: To Generate a Pulse Wave

How to generate a Pulse waveform with 5kHz Frequency, 50mV High Level, -5mV Low Level, 20 μ s Pulse Width and 10ns Edge Time.

The operation steps:

1. Set the Frequency.
 - (1) Press **Pulse** \rightarrow **Freq/Period** and choose **Freq** which will display in reverse color.
 - (2) Input "5" from the keypad and choose "kHz" to set the Frequency as 5 kHz.
2. Set the High Level.
 - (1) Press **Ampl/ HiLev** and choose **HiLev** which will display in reverse color.
 - (2) Enter "50" from the keypad and choose the unit "mV" to set the High Level as 50mV.
3. Set the Low Level.
 - (1) Press **Offset /LoLev** to choose **LoLev** which will display in reverse color.
 - (2) Enter "-5" from the keypad and choose the unit "mV" to set the Low Level as -5mV.
4. Set the Pulse Width.
 - (1) Press **DtyCyc/Width** and choose **Width** which will display in reverse color.
 - (2) Enter "20" from the keypad and choose the unit " μ s" to set the Pulse Width as 20 μ s.

When the Frequency, High Level, Low Level and Pulse Width were set, the generated waveform is shown in Figure 3-4.

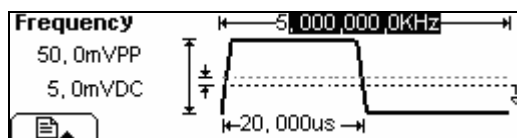

Figure 3-4 Pulse Waveform Output

Example 5: To Generate a Noise Wave

How to generate a Noise waveform with 30mV_{PP} Amplitude and 10mV_{DC} Offset.

The operation steps:

1. Set the Amplitude.
 - (1) Press **Ampl/ HiLev** and choose **Ampl** which will display in reverse color.
 - (2) Enter "30" from the keypad and choose the unit "mv_{pp}" to set the Amplitude as 30mV_{PP}.
2. Set the Offset.
 - (1) Press **Offset/ LoLev** to choose **Offset** which will display in reverse color.
 - (2) Enter "10" from the keypad and choose the unit "mV_{DC}" to set the Offset as 10mV_{DC}.

When the Amplitude and Offset were set, the generated waveform is shown in Figure 3-5.



Figure 3-5 Noise Waveform Output

Example 6: To Generate Arbitrary Waveform

How to generate an arbitrary waveform (Sinc) with 2MHz Frequency, 5V_{RMS} Amplitude and 0 V_{DC} Offset.

The operation steps:

1. Set the Type of the Arbitrary Waveform.
 - (1) Press **Arb** → **Load**, to choose the built-in waveform.
 - (2) Press **BuiltIn** → **Sinc**, There are five built-in arbitrary waveforms. Choose **Sinc**, and press any key to return the Main Menu of **Arb**.

2. Set the Frequency.
 - (1) Press **Pulse** → **Freq/Period** and choose **Freq** which will display in reverse color.
 - (2) Input "2" from the keypad and choose the unit "MHz" to set the Frequency as 2MHz.

3. Set the Amplitude.
 - (1) Press **Ampl/ HiLev** and choose **Ampl** which will display in reverse color.
 - (2) Enter "5" from the keypad and choose the unit "V_{RMS}" to set the Amplitude as 5 V_{RMS}.

4. Set the Offset.
 - (1) Press **Offset /LoLev** to choose **Offset** which will display in reverse color.
 - (2) Enter "0" from the keypad and choose the unit "V_{DC}" to set the Offset as 0 V_{DC}.

When the Arbitrary type of a Waveform, Frequency, Amplitude and Offset were set, the generated waveform is shown in Figure 3-6.

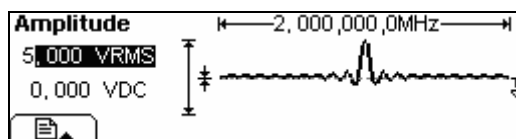

Figure 3-6 Sinc Waveform Output

Right now, the selected waveform is appointed to **Arb**. This waveform will put out once the key is pressed. Press **Arb** to confirm what kind of waveform is selected.

Example 7: To Generate an Arbitrary Waveform

How to generate an arbitrary Waveform as the figure shows below (the Self-Defined Waveform is Ramp).

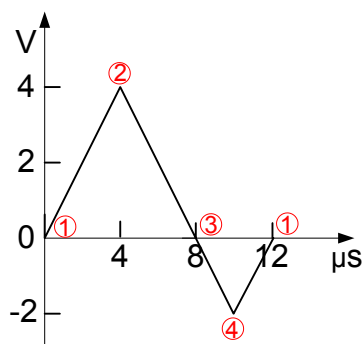

Figure 3-7
Arbitrary Waveform Output

The operation steps:

1. Create a new Waveform:
Press **Arb** → **Edit** → **Create**, to activate the waveform editing function. The waveform is defined by setting the time and voltage of the points.
2. Set the period.
 - (1) Press **Period** which will display in reverse color.
 - (2) Input "12" from the keypad and choose the unit "μs" to set the Period as 12μs.
3. Set the Voltage Limit.
 - (1) Press **LevelHi**, and enter "4" from the keypad, choose the unit "V", to set the High Level as 4V.
 - (2) Press **LevelLo**, and enter "-2" from the keypad, choose the unit "V", to set the low Level as -2V.
4. Set the Number of the initializing Points.
Set the Initializing Point Number as "4".
5. Choose the Interpolation Method.
Press **Interp.** → **Interpolation On**, to perform linear connection between the points.

6. Edit the Waveform Points.

Edit the Voltage and Time of the points to define a waveform. Insert or delete the point If needed.

Press **Points**, use the knob or the keypad to shift the point number. The voltage and time of the points are defined below in Table 3-1.

Table 3-1 The Setting of Time and Voltage of the points

Point	Time	Voltage
1	0s	0V
2	4μs	4V
3	8μs	0V
4	10μs	-2V

7. To save the Waveform.

Press **Save**, to store the waveform in one of the 4 Non-Volatile Memories.

Press **Store**, to store the finished waveform in the Volatile Memory. Only one self-built waveform can be stored. If a new one is stored, the old one will be erased.

The waveform is generated through the steps above. The waveform is shown in Figure 3-8.

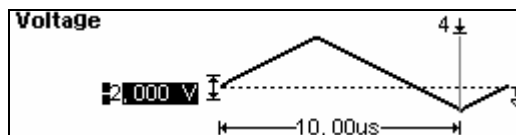

Figure 3-8 The Self-Defined Ramp Waveform

Example 8: To Generate an AM Waveform

How to generate an AM Waveform with depth of 70%, The Carrier is a Sine Wave with 2.5 kHz Frequency, and the modulating Wave is a Sine Wave with 150 Hz Frequency.

The operation steps:

1. Choose the Carrier Function:
Press **Sine**, and choose the Sine Waveform as the Carrier Wave.
The default setting of the Source is internal.
2. Set the Frequency, Amplitude and Offset.
 - (1) Press **Period/Freq** and choose **Freq** which will display in reverse color. Input "2.5" from the keypad and choose the unit "kHz" to set the Frequency as 2.5kHz.
 - (2) Press **Ampl/HiLev** and choose **Ampl** which will display in reverse color. Input "2" from the keypad and choose the unit "V_{pp}" to set the Amplitude as 2 V_{pp}.
 - (3) Press **Offset/LoLev** and choose **Offset** which will display in reverse color. Input "0" from the keypad and choose the unit "V_{DC}" to set the Offset as 0 V_{DC}.
3. Set the Modulation Type AM.
Press **Mod** → **Type** → **AM**, Please notice that the message shown on the top left side of the screen is "AM".
4. Set the Modulation Depth.
Press **Depth**, use the keypad to enter "70", choose the unit "%", setting the Modulation Depth as 70%.
5. Set the AM Frequency.
Press **AMFreq**, use the keypad to enter "150", choose the unit "Hz", setting the AM Frequency as 150Hz.
6. Choose the Modulating Waveform.
Press **Shape** → **Sine**, to choose Sine Waveform as the Modulating Waveform.
Please note that the State Message on the top left side of the screen shows "Sine".

At this time, the instrument generates the specified AM waveform. The Waveform is shown in Figure 3-9.

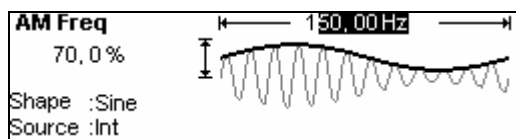

Figure 3-9 The AM Output

7. Turn off the Modulation Function.
Press the lighted **Mod** Key to turn off the Modulation Function.

Example 9: To Generate an FSK Waveform

How to generate a FSK Waveform with FSK Rate of 200Hz, The Carrier is a Sine Wave with 10 kHz Frequency, and the Hop Frequency is 800 Hz.

The operation steps:

1. Choose the Carrier Function.
Press **Sine**, and choose the Sine Waveform as the Carrier Function.
The default setting of the Source is Internal.
2. Set the Frequency, Amplitude and Offset.
 - (1) Press **Period/Freq** and choose **Freq** which will display in reverse color. Input "10" from the keypad and choose the unit "kHz" to set the Frequency as 10 kHz.
 - (2) Press **Ampl/HiLev** and choose **Ampl** which will display in reverse color. Input "2" from the keypad and choose the unit "Vpp" to set the Amplitude as 2 Vpp.
 - (3) Press **Offset/LoLev** and choose **Offset** which will display in reverse color. Input "0" from the keypad and choose the unit "VDC" to set the Offset as 0 VDC.
3. Set the Modulation Type FSK.
Press **Mod** → **Type** → **FSK**, choose FSK. Please notice that the message shown on the top left side of the screen is "FSK".
4. Set the FSK Rate.
Press **FSKRate**, use the keypad to enter "200", choose the unit "Hz", setting the FSK Rate as 200Hz.
5. Set the Hop Frequency.
Press **HopFreq**, use the keypad to enter "800", choose the unit "Hz", setting the Hop Frequency as 800Hz.

At this time, the instrument generates the specified AM waveform. The Waveform is shown in Figure 3-10.

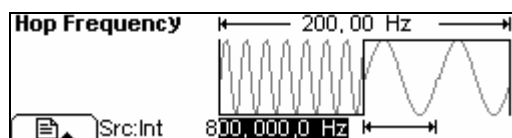

Figure 3-10 The FSK Output

6. Turn off the Modulation Function.
Press the lighted **Mod** Key to turn off the Modulation Function.

Example 10: To Generate a Linear Sweep Waveform

How to generate a Sine Sweep Waveform whose frequency starts from 100Hz to 10kHz. Use the Internal Trigger Mode, Linear Sweep, and the Sweep is 1s.

The operation steps:

1. Choose the Sweep Function.
Press **Sine**, and choose the Sine Waveform as the Sweep Function.
The default setting of the Source is Internal.
2. Set the Frequency, Amplitude and Offset.
 - (1) Press **Period/Freq** and choose **Freq** which will display in reverse color. Input "5" from the keypad and choose the unit "kHz" to set the Frequency as 5 kHz.
 - (2) Press **Ampl/HiLev** and choose **Ampl** which will display in reverse color. Input "2" from the keypad and choose the unit "V_{PP}" to set the Amplitude as 2 V_{PP}.
 - (3) Press **Offset/LoLev** and choose **Offset** which will be displayed in reverse color. Input "0" from the keypad and choose the unit "V_{DC}" to set the Offset as 0 V_{DC}.
3. Set the Sweep Mode.
Press **Mod** → **Linear/Log** and choose Linear. Please notice that the message shown on the top left side of the screen is "Linear".
4. Set the Sweep Time.
Press **Time**, use the keypad to enter "1", choose the unit "s", to set the Sweep Time as 1s.
5. Set the Start Frequency.
Press **Start**, use the keypad to enter "100", choose the unit "Hz", to set the Start Frequency as 100Hz.
6. Set the Stop Frequency.
Press **Stop**, use the keypad to enter "10", choose the unit "kHz", to set the Stop Frequency as 10 kHz.

At this time, the instrument generates the specified Sweep waveform whose frequency starts from 100Hz and stops at 10 kHz. The Waveform is shown in Figure 3-11.

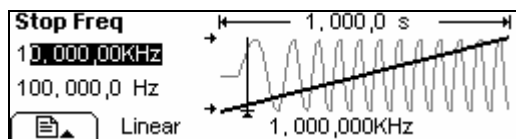

Figure 3-11
The Sweep Waveform Output

Instructions

If necessary, you can set the frequency Limits by setting the Center Frequency and the frequency range. These parameters are similar to the Start and Stop frequency, which will provide more flexibility for you. To generate the same waveform, set the Center Frequency to be 5.050 kHz, the frequency range is 9.900 kHz.

Example 11: To Generate a Burst Waveform

How to generate a Burst Waveform with the Cycle is 3. The period is 10ms. But you cannot change parameters in the default setting: Internal Source and 0 degree Phase.

The operation steps:

1. Choose the Burst Function.
Press **Square**, and choose the Square Waveform as the Burst Function.
The default setting of the Source is Internal.
2. Set the Frequency, Amplitude and Offset.
 - (1) Press **Period/Freq** and choose **Freq** which will display in reverse color. Input "5" from the keypad and choose the unit "kHz" to set the Frequency as 5 kHz.
 - (2) Press **Ampl/HiLev** and choose **Ampl** which will display in reverse color. Input "5" from the keypad and choose the unit "Vpp" to set the Amplitude as 5 Vpp.
 - (3) Press **Offset/LoLev** and choose **Offset** which will display in reverse color. Input "0" from the keypad and choose the unit "VDC" to set the Offset as 0 VDC.
3. Set the Sweep Mode.
Press **Burst** → **NCycle** choose N-Cycle Mode. Please note that the message shown on the top left side of the screen is "N Cycle".
4. Set the Burst Period.
Press **Period**, use the keypad to enter "10", choose the unit "ms" and set the Period as 10 ms (Please note the icon).
5. Set the Start Phase.
Press **Phase**, use the keypad to enter "0", choose the unit "°", setting the Start phase as 0°.
6. Set the Burst Cycles.
Press **Cycles**, use the keypad to enter "3", choose the unit "Cyc", setting the Burst Cycle as 3.

7. Set the Delay.

Press **Delay**, use the keypad to enter "200", choose the unit " μs ", setting the Burst Delay as $200\mu\text{s}$.

At this time, the instrument generates the specified 3- Cycle Burst waveform with a period of 10ms. The waveform is shown in Figure 3-12.

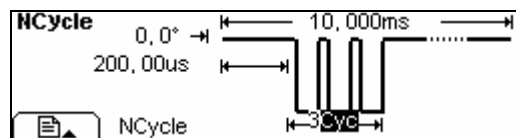

Figure 3-12 The Burst Waveform Output

Example 12: To Measure the Frequency

How to measure the frequency of an unknown signal.

The operation steps:

1. Press **Count**, enter the frequency measure mode.
2. Put the signal to be measure to the input of the counter.
3. To set the measurement:
 - (1) Auto measure mode.
Press **Trig/Run**, enter the AUTO mode, in this mode, the coupling mode is AC, the counter automatically adjusts the trig level and sensitivity until the display is steady.
 - (2) Manually measure mode:
 - To set the coupling mode
Press **Setup** → **AC/DC**, choose "AC";
 - To set the sensitivity
Press **Setup** → **Sensitivity** → **Medium**;
 - To set the trigger level
Press **Setup** → **TrigLev**, use the keyboard input "62.0", the trigger level is set to be 0.72V.
 - To set the high frequency restrain On/Off
Press **Setup** → **HFRon/Off**, choose "HFROff".

After all the set was done, the counter will measure the signal according to the current set. If the reading is unsteady, please repeat the above step until it is steady.

4. To view the result.
 - (1) Frequency view: In default state, the measure result is frequency value, see figure 3-13;

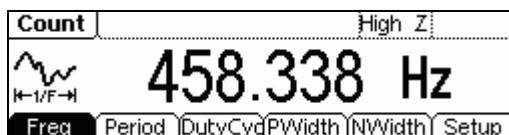

Figure 3-13

(2) Period view: press **Period**, the period will display as figure 3-14;

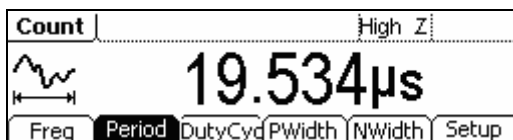

Figure 3-14

(3) Duty cycle view: press **DutyCyc**, the Duty cycle will display as figure 3-15;

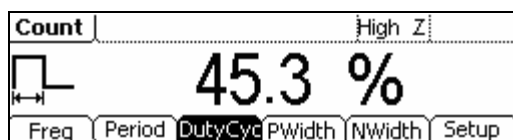

Figure 3-15

(4) Positive width view: press **PWidth**, the positive width will display as figure 3-16;



Figure 3-16

(5) Negative width view: press **NWidth**, the negative width will display as figure 3-17.

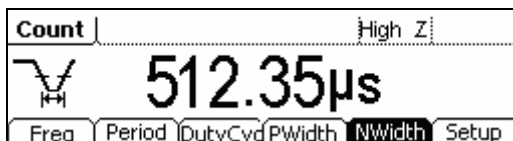

Figure 3-17

Chapter 4 Prompt messages & troubleshooting

Prompting Messages

Common Prompt Messages

Need Help? Press and hold down any key.

Prompt Message 1. While using the instrument, users can get help by using the method shows above.

Settings are restored from last power-down.

Prompt Message 2. To inform the user that all the settings have been restored and you can operate the instrument normally.

Selected interface is USB, no USB device detected!

Prompt Message 3. When the instrument is powered, it detects that the current I/O is USB, and informs the user that no new USB device is detected.

No Changes.

When the waveform parameter is being altered, if the user cancels the operation, the message will prompt.

Selected arb is **

This is to inform the user that the selected arbitrary waveform type is the built-in ExpRise / ExpFall / NegRamp / Sinc / Cardiac waveform or the waveform that the user built. To change it, press **Load** → **BuiltIn**, **Stored** or **Volatile**.

Please Wait...

It takes time to save or recall the data, and this message is to tell the user to wait.

First, set the allover waveform parameters.

To inform the user, set the general waveform parameter first. Then set the parameters for each point.

Edit the existing waveform parameters.

Perform the waveform edit operation, and inform the user that operation can be taken to edit the current waveform parameter.

The selected arbitrary waveform is Volatile.

Inform the user that the selected waveform is Volatile.

Are all settings Restore to factory defaults?

If user wants to reset the instrument to the default setting, the system will prompt this message, to confirm the operation, in case of accidental mistake.

All settings are restored to factory defaults.

When all the settings of the instrument have been reset to the default state, this message will prompt to inform the user.

Storing waveform, please wait...

Inform the user that the saving operation is in process.

Waveform has been stored, as required.

Save the waveform to the specific place according to the user's request. Once the waveform is saved, this message prompts.

Performing Self-Test, Please wait...

When the Self-Test is performing, this message will prompt to inform the user to wait, since it takes time.

Self-Test Passed.

When the Self-Test is finished, the result will be reported to the user. If the Self-test has been passed, this message will prompt.

The instrument now is UNSECURED.

Inform the user that the password is correct and the user can calibrate the instrument now. The instrument is unsecured.

Instrument triggered.

The manual trigger mode is activated, and the expected burst or sweep will generate.

Selected modulating arb is **:

Inform the user of the information about the selected modulating waveform.

Calibration Count=0, Reversion=04040109:

Inform the user of the Calibration time and the version. Before the instrument is shipped, it has already been calibrated. When you power a new instrument, the default calibration time is 0. The latest version can be reached at the company's website: [http:// www.rigol.com](http://www.rigol.com).

Calibrating, Please wait...

In the Calibration menu, inform the user to wait when the instrument is preparing to calibrate.

File doesn't exist!

When deleting the file, to inform the user that the file does not exist.

Complete. Waveform setting have been changed.

Inform the user that the file has been recalled and the display the set waveform.

Complete. Waveform data have been changed.

Inform the user that the file has been recalled and display the set arbitrary waveform's data.

Please select type.

When storing the file and the storage type is "all", inform the user to choose the storage type.

Insufficient space. Fail to Save.

If the file to be stored is too large, and the Non-Volatile Memory does not have enough space, the new file can not be stored. This is to inform the user that the storage operation failed.

Fail to read file.

If there is no file in the place the user selects, no file can be read and this message is to inform the user that the file recall operation failed.

Please select a valid File.

If the selected place is empty when recall or delete a file, this message will appear.

State extension".rsf"; data extension".rdf".

This message appears when the user enter the Store/Recall interface.

Delete the file?

Confirm the deletion operation, in case of accidental operation.

Cover the file?

If the current place has already been used when the user wants to store the file, this message will appear to confirm the operation. If the user continues, the old file will be covered. Press "Yes" to continue; Press "Cancel" to reselect the place.

Can't Write this File to system

This message appears when the operation of burning menu or programs into the system from the U Disk fails.

File is too big.

If the menu or programs are too large to be burnt into the system from the U Disk, this message will appear to inform the user that the operation fails.

Invalid File, Fail to update.

When using the U Disk to update the system, if the updating file is void, this message will appear to inform the user that the system updating operation can not be performed.

Updating is completed. Restart the instrument.

If the updating of the System is successful by using the U disk, this message will appear. The instrument has to be restarted to update the settings. It also informs the user that if a technical problem occurs after the updating, contact the **RIGOL** technician for support.

Invalid code.

When the user is updating the system, if the system updating operation password is wrong, this message will appear.

Valid code. System update is permitted.

When the user is updating the system, if the system updating operation password is correct this message will appear.

Wave file will cover.

If the arbitrary waveform to be stored is larger than 128K, other places will be used to store the waveform.

Mobile disk installation is error!

U disk installation failed, and the system could not identify it.

Error Messages

Incorrect secure code, please try again.

Users have to enter the correct password before they calibrate the instrument. If the password is incorrect, this message will appear to inform the user enter the password again.

Please first complete step:**

Before the instrument is calibrated, if the user wants to perform the selected calibration procedure, this is to inform the user to start from step**.

Select units to enter value or press CANCEL.

When a parameter is input, inform the user "Choose the parameter unit" to finish changing the parameter or press **Cancel** button to cancel the current operation.

Trigger ignored.

If groups of GET commands or * Trigger is received, the system will ignore the grouped GET commands to secure the right source.

Instrument is in remote mode. Press Local.

If the instrument is in Remote Mode, the front panel will be nullified. Press **Local** (also ) to shift the instrument mode into local, so that the front panel can work.

Initial # of points upper limit=4K

The upper limit of the initial points is 4,096. If the specified waveform has more than 4,096 points, the system will adjust the number to 4,096 automatically.

Conflict Settings

Turned off infinite burst.

Infinite burst is allowed only when the source is external or manual. The upper limit of the burst cycle is 50,000.

Trigger source changes to Ext/Manual.

Only when the External or Manual Trigger Source is selected, the infinite burst is allowed.

Burst period increased to fit entire burst.

The PRI of Period is higher than that of the Burst Period. As long as the burst period does not reach its maximum, the generator will increase the burst period to cater to the need of the specific burst cycle or waveform frequency.

Burst count reduced.

If the burst period has reached its maximum, reduce the burst count to meet the need of the specified waveform frequency.

Trigger delay reduced to fit entire burst.

Trigger delay will be reduced to fit the current burst period and burst count. Trigger delay is the time between the time trigger is received and the start of the burst.

Sorry, unable to N-cycle burst with noise.

Noise cannot be used in the trigger burst mode; it can only be used in the gated burst.

Triggered burst not available for noise.

Noise cannot be used in the trigger burst mode; it can only be used in the gated burst.

Trigger ignored -OUTPUT is off.

When the OUTPUT is disabled, the Trigger Output will be disabled automatically.

Trigger output connector used by FSK.

If the FSK is activated and the Source is external, no "Trigger Output" is allowed.

Trigger output connector used by burst gate.

If the gated burst mode is activated and the burst is also activated, no "Trigger Output" is allowed.

Frequency is set maximum for Arb.

The maximum frequency for the arbitrary waveform is 5MHz. when a waveform of

higher frequency is changed to the arbitrary waveform, the system will adjust the frequency to 5MHz automatically.

Frequency is set maximum for Pulse.

The maximum frequency for the pulse is 3MHz. when a waveform of higher frequency is changed to the pulse waveform, the system will adjust the frequency to 3MHz automatically.

Frequency is set maximum for ramp.

The maximum frequency for Ramp is 150kHz. When a waveform of higher frequency is changed to the Ramp waveform, the system will automatically adjust the frequency to 150kHz.

Frequency is set maximum for Burst.

For an internal burst, the minimum frequency is 2mHz, and the maximum is 8MHz. The generator will adjust the frequency to be compatible with the currently specified one automatically.

Frequency is set minimum for Burst.

For an internal burst, the minimum frequency is 2mHz, and the maximum is 8MHz. The generator will adjust the frequency to be compatible with the currently specified one automatically.

Sorry, unable to modulate Pulses.

Noise, Pulse and DC cannot be modulated using AM, FM, PM or FSK methods.

Sorry, unable to modulate Noise.

Noise, Pulse and DC cannot be modulated using AM, FM, PM or FSK methods.

Sorry, unable to modulate DC.

Noise, Pulse and DC cannot be modulated using AM, FM, PM or FSK methods.

Sorry, unable to sweep Pulses.

Pulse, Noise and DC cannot be used to generate sweep signals.

Sorry, unable to sweep Noise.

Pulse, Noise and DC cannot be used to generate sweep signals.

Sorry, unable to sweep DC.

Pulse, Noise and DC cannot be used to generate sweep signals.

Modulation has been turned off to allow Pulse.

Pulse, noise and DC are not allowed to generate modulated waveform. So the modulation has to be turned off to allow Pulse.

Modulation has been turned off to allow Noise.

Pulse, noise and DC are not allowed to generate modulated waveform. So the modulation has to be turned off to allow Noise

Modulation has been turned off to allow DC.

Pulse, noise and DC are not allowed to generate modulated waveform. So the modulation has to be turned off to allow DC

Sweep has been turned off to allow Pulse.

Pulse, noise and DC are not allowed to generate Sweep waveform. So the modulation has to be turned off to allow Pulse.

Sweep has been turned off to allow Noise.

Pulse, noise and DC are not allowed to generate Sweep waveform. So the modulation has to be turned off to allow Noise.

Sweep has been turned off to allow DC.

Pulse, noise and DC are not allowed to generate Sweep waveform. So the modulation has to be turned off to allow DC.

Manual Trigger only for Sweep, N-Cycle Burst.

Manual Trigger is only used for Sweep and N-Cycle Burst.

Trigger Source has been changed to Manual.

When Trig/Run is enabled, the source type turns from internal to manual.

Pulse width was reduced by period.

For a pulse waveform, the generator will adjust the waveform parameter automatically to fit the need of the pulse according to the order below: Edge time-Pulse Width-Period. In this case, the generator will reduce the pulse width to cater to the need of the period. The Edge Time is already set to the minimum value.

Amplitude (V_{RMS}) upper limit =3.536V_{rms}

For example: if a square wave with the amplitude of 5 V_{RMS} connects to a 50 ohm resistance was turned into a sine waveform, then the generator will change the amplitude to 3.536 V_{RMS} automatically.

Offset has changed due to Amplitude.

In DC voltage function, voltage level is adjusted through the change of the offset, and the current amplitude will be ignored. When changing to the other function, the generator will adjust the offset voltage to fit the current amplitude setting.

Deviation has been changed due to carrier frequency.

The Carrier frequency should always be greater than or equal to the deviation

frequency. If the carrier frequency is set less than the deviation frequency, when FM is activated, the generator will adjust the deviation frequency to the value automatically that the current carrier frequency allows.

Duty cycle is limited at a higher frequency.

If the waveform is set Square and the frequency is set to a value which does not allow the current Duty Cycle, the Duty Cycle will adjust to the value automatically that the current frequency allows. For example, if the current frequency is 2MHz, Duty Cycle is 70%, and the frequency is changed to 5 MHz, the Duty Cycle will be changed to 50%.

For a frequency less than 3 MHz (include), the Duty Cycle range is 20% to 80%.

For a frequency between 3 MHz and 4 MHz(include), the Duty Cycle range is 40% to 60%; For a frequency between 4 MHz and 5 MHz, the Duty Cycle is 50%.

Other parameters were modified.

For the Pulse Waveform, the generator will adjust the following parameters automatically in the order below to generate the pulse waveform: Edge time- Pulse Width-Period. When the period changes, the Edge Time and Pulse Width will also change according to the period.

Burst type has been changed to N-Cycle.

When the Trigger Source is turned from External/ Manual to Internal, the Burst Mode should be changed to N-Cycle.

Sorry, unable to burst DC.

The generator can not use DC Voltage function to generate Burst.

Burst has been turned off to allow DC.

The generator can not use DC to generate Burst. So the Burst is turned off.

Data Overflow

Sine Wave frequency upper limit=20MHz

The Sine wave frequency upper limit is 20MHz. If the specified frequency is higher than 20MHz, the system will adjust the frequency to 20MHz automatically.

Sine Wave frequency lower limit= 1μHz

The Sine wave frequency lower limit is 1μHz. If the specified frequency is lower than 1μHz, the system will adjust the frequency to 1μHz automatically.

Square Wave frequency upper limit=5MHz

The Square wave frequency upper limit is 5MHz. If the specified frequency is higher than 5MHz, the system will adjust the frequency to 5MHz automatically.

Square Wave frequency lower limit=1μHz

The Square wave frequency lower limit is 1μHz. If the specified frequency is lower than 1μHz, the system will adjust the frequency to 1μHz automatically.

Ramp Wave frequency upper limit= 150kHz

The Ramp wave frequency upper limit is 150 kHz. If the specified frequency is higher than 150kHz, the system will adjust the frequency to 150 kHz automatically.

Ramp Wave frequency lower limit= 1μHz

The Ramp wave frequency lower limit is 1μHz. If the specified frequency is lower than 1μHz, the system will adjust the frequency to 1μHz automatically.

Pulse Wave frequency upper limit=3MHz

The Pulse wave frequency upper limit is 3MHz. If the specified frequency is higher than 3MHz, the system will adjust the frequency to 3MHz automatically.

Pulse Wave frequency lower limit= 500 μHz

The Pulse wave frequency lower limit is 500μHz. If the specified frequency is lower than 500μHz, the system will adjust the frequency to 500μHz automatically.

Arb Wave frequency upper limit= 5 MHz

The Arb wave frequency upper limit is 5MHz. If the specified frequency is higher than 5MHz, the system will adjust the frequency to 5MHz automatically.

Arb Wave frequency lower limit= 1μHz

The Arb wave frequency lower limit is 1μHz. If the specified frequency is lower than 1μHz, the system will adjust the frequency to 1μHz automatically.

Sine Wave period upper limit= 1 Ms

The Sine Wave Period upper limit is 1Ms. If the specified period is greater than 1Ms, the system will adjust the period to 1Ms automatically.

Sine Wave period lower limit= 50ns

The Sine Wave Period lower limit is 50ns. If the specified period is less than 50ns, the system will adjust the period to 50ns automatically.

Square Wave period upper limit= 1 Ms

The Square Wave Period upper limit is 1Ms. If the specified period is greater than 1Ms, the system will adjust the period to 1Ms automatically.

Square Wave period lower limit= 200 ns

The Square Wave Period lower limit is 200ns. If the specified period is less than 200ns, the system will adjust the period to 200ns automatically.

Ramp Wave period upper limit= 1 Ms

The Ramp Wave Period upper limit is 1Ms. If the specified period is greater than 1Ms, the system will adjust the period to 1Ms automatically.

Ramp Wave period lower limit= 6.67 μ s

The Ramp Wave Period lower limit is 6.67 μ s. If the specified period is less than 6.67 μ s, the system will adjust the period to 6.67 μ s automatically.

Pulse Wave period upper limit= 2 Ks

The Pulse Wave Period upper limit is 2Ks. If the specified period is greater than 2Ks, the system will adjust the period to 2Ks automatically.

Pulse Wave period lower limit= 333.33 ns

The Pulse Wave Period lower limit is 333.33ns. If the specified period is less than 333.33ns, the system will adjust the period to 333.33ns automatically.

Arb Wave period upper limit= 1 Ms

The Arb Wave Period upper limit is 1Ms. If the specified period is greater than 1Ms, the system will adjust the period to 1Ms automatically.

Arb Wave period lower limit= 200.0ns

The Arb Wave Period lower limit is 200.0ns. If the specified period is less than ns, the system will adjust the period to 200.0ns automatically.

Amplitude upper limit= **

Different mode has different amplitude upper limit; amplitude upper limit may vary in the same mode if the load is different.

Amplitude lower limit= **

Different mode has different amplitude lower limit; amplitude lower limit may vary in the same mode if the load is different.

High level upper limit = **

Different mode has different High Level upper limit; High Level upper limit may vary in the same mode if the load is different.

Low level lower negative limit=**

Different mode has different High Level lower limit; High Level lower limit may vary in the same mode if the load is different.

High level must be greater than Low level

High level must always be greater than Low level. If the high level is set less than the low level, the generator will set the low level 1 mV less than the high level automatically.

Duty Cycle upper/lower limit = **

In the Square mode, different frequency range corresponds to different Duty Cycle limit.

For a frequency lower than 3 MHz (include), the range is from 20% to 80%;

For a frequency between 3~4 MHz (include), the range is from 40% to 60%;

For a frequency between 4~5 MHz, the Duty Cycle is set to be 50%.

Symmetry upper limit = 100.0%

In the Ramp mode, the Symmetry upper limit is 100%. If the specified symmetry is greater than 100%, the system will adjust the symmetry to 100% automatically.

Symmetry lower negative limit = 0.0%.

In the Ramp mode, the Symmetry lower limit is 0.0%. If the specified symmetry is less than 0.0%, the system will adjust the symmetry to 0.0% automatically.

Pulse Width is limited by Period

The Pulse Width should be less than the difference of the period and the Edge Time.

Pulse width lower limit = 8.0ns

In the Pulse mode, the Pulse width lower limit is 8.0ns. If the specified pulse width is less than 8.0ns, the system will adjust the pulse width to 8.0ns automatically.

Offset upper limit= **

Different mode has different Offset upper limit; Offset upper limit may vary in the same mode if the load is different.

Offset lower negative limit = **

Different mode has different Offset lower limit; Offset lower limit may vary in the

same mode if the load is different.

Initial # of points upper limit =4K

The number of initial points upper limit is 4,096. If the specified waveform has more than 4,096 points, the system will adjust the point number to 4,096 automatically.

Initial # of points lower limit=2.

The default initial point number is 2, the lower limit of the initial points. If the specified initial point is less than 2, the system will adjust the number to 2 automatically.

Point # lower limit=1.

When the user is editing the point, if the input number is less than 1, the system will inform the user to start from point #1.

Currently on the last defined point.

When the user is about to edit the last defined point, this message will prompt.

Deviation cannot exceed Carrier Frequency.

The carrier Frequency should always be higher than or equal to the deviation frequency.

Frequency Deviation lower limit = 1μHz.

Frequency deviation lower limit is 1μHz. If the specified Frequency deviation is lower than 1μHz, the system will adjust the Frequency deviation to 1μHz automatically.

FM Frequency upper limit =20kHz

FM Frequency upper limit is 20 kHz. If the specified FM Frequency is higher than 20kHz, the system will adjust the FM Frequency to 20kHz automatically.

FM Frequency lower limit = 2mHz

FM Frequency lower limit is 2mHz. If the specified FM Frequency is lower than 2mHz, the system will adjust the FM Frequency to 2mHz automatically.

Deviation plus Carrier cannot exceed maximum.

The sum of the Carrier frequency and the deviation frequency should be lower than or equal to the selected maximum frequency plus 100 kHz.

AM Depth upper limit = 120.0%.

The AM Depth upper limit is 120.0%. If the specified AM Depth is greater than 120.0%, the system will adjust the AM Depth to 120.0% automatically.

AM Depth lower limit = 0.0%.

The AM Depth lower limit is 0.0%. If the specified AM Depth is less than 0.0%, the

system will adjust the AM Depth to 0.0% automatically.

AM Frequency upper limit = 20kHz

The AM Frequency upper limit is 20 kHz. If the specified AM Frequency is higher than 20kHz, the system will adjust the AM Frequency to 20kHz automatically.

AM Frequency lower limit = 2mHz

The AM Frequency lower limit is 2mHz. If the specified AM Frequency is lower than 2mHz, the system will adjust the AM Frequency to 2mHz automatically.

Hop Frequency upper limit = **

Different Source types have different Hop Frequency upper limit. If the Carrier is a Sine wave or Square wave, the Hop Frequency upper limit is 20MHz; If the Carrier is a Ramp wave, the Hop Frequency upper limit is 150KHz; If the Carrier is an Arb wave, the Hop Frequency upper limit is 5MHz.

Hop Frequency lower limit = 1 μHz

The Hop Frequency lower limit is 1μHz. If the specified Hop Frequency is lower than 1μHz, the system will adjust the Hop Frequency to 1μHz automatically.

FSK Rate upper limit = 50 kHz

The FSK Rate upper limit is 50 kHz. If the specified FSK Rate is greater than 50kHz, the system will adjust the FSK Rate to 50kHz automatically.

FSK Rate lower limit = 2mHz

The FSK Rate lower limit is 2mHz. If the specified FSK Rate is less than 2mHz, the system will adjust the FSK Rate to 2mHz automatically.

Phase deviation upper limit=360°

The Phase deviation upper limit is 360°. If the specified Phase deviation is greater than 360°, the system will adjust the Phase deviation to 360° automatically.

Phase deviation lower limit= 0°

The Phase deviation lower limit is 0°. If the specified Phase deviation is less than 0°, the system will adjust the Phase deviation to 0° automatically.

PM Frequency upper limit= 20 kHz

The PM Frequency upper limit is 20 kHz. If the specified PM Frequency is higher than 20 kHz, the system will adjust the PM Frequency to 20 kHz automatically.

PM Frequency lower limit= 2mHz

The PM Frequency lower limit is 2mHz. If the specified PM Frequency is lower than 2mHz, the system will adjust the PM Frequency to 2mHz automatically.

Start Frequency upper limit = **

Different Source types have different Start Frequency upper lower. If the Carrier is a Sine wave or Square wave, the Start Frequency upper limit is 20MHz; If the Carrier is a Ramp wave, the Start Frequency upper limit is 150KHz; if the Carrier is an Arb wave, the Start Frequency upper limit is 5MHz.

Start Frequency lower limit = 1 μ Hz

The Start Frequency lower limit is 1 μ Hz. If the specified Start Frequency is lower than 1 μ Hz, the system will adjust the Start Frequency to 1 μ Hz automatically.

Stop Frequency upper limit = **

Different Source types have different Stop Frequency upper lower. If the Carrier is a Sine wave or Square wave, the Stop Frequency upper limit is 20MHz; If the Carrier is a Ramp wave, the Stop Frequency upper limit is 150KHz; If the Carrier is an Arb wave, the Stop Frequency upper limit is 5MHz.

Stop Frequency lower limit = 1 μ Hz

The Stop Frequency lower limit is 1 μ Hz. If the specified Stop Frequency is lower than 1 μ Hz, the system will adjust the Stop Frequency to 1 μ Hz automatically.

Center Frequency upper limit = **

Different Source types have different Center Frequency upper limit. If the Carrier is a Sine wave or Square wave, the Center Frequency upper limit is 20MHz; If the Carrier is a Ramp wave, the Center Frequency upper limit is 150KHz; If the Carrier is an Arb wave, the Center Frequency upper limit is 5MHz.

Center Frequency lower limit = 1 μ Hz

The Center Frequency lower limit is 1 μ Hz. If the specified Center Frequency is lower than 1 μ Hz, the system will adjust the Center Frequency to 1 μ Hz automatically.

Frequency span upper limit = **

With different Source type modes and center frequencies, the frequency span upper limits vary. If the Carrier is a Sine wave or Square wave, the Center Frequency upper limit is 19.999,998 MHz; If the Carrier is a Ramp wave, the Center Frequency upper limit is 149.999,99 kHz; If the Carrier is an Arb wave, the Center Frequency upper limit is 4.999,998 MHz.

Frequency span lower limit = **

With different Source type modes and center frequencies, the frequency span lower limits vary. If the Carrier is a Sine wave or Square wave, the Center Frequency lower limit is -19.999,998 MHz; If the Carrier is a Ramp wave, the Center Frequency lower limit is -149.999,99 kHz; If the Carrier is an Arb wave, the Center Frequency lower

limit is -4.999,998 MHz.

Sweep Time upper limit = 500.00s

The Sweep Time upper limit is 500.00s. If the specified Sweep Time is greater than 500.00s, the system will adjust the Sweep Time to 500.00s automatically.

Sweep Time lower limit = 1.0ms

The Sweep Time lower limit is 1.0ms. If the specified Sweep Time is less than 1.0ms, the system will adjust the Sweep Time to 1.0ms automatically.

Phase upper limit= +360.0°

The Phase upper limit is +360.0°. If the specified Phase is greater than +360.0°, the system will adjust the Phase to +360.0 ° automatically.

Phase lower negative limit= - 360.0°

The Phase lower negative limit is -360.0°. If the specified Phase is less than -360.0°, the system will adjust the Phase to -360.0° automatically.

of Cycles upper limit = 50,000 Cyc

The Cycle upper limit is 50,000Cyc. If the specified Cycle is greater than 50,000Cyc, the system will adjust the Cycle to 50,000Cyc automatically.

of Cycles lower limit = 1 Cyc

The Cycle lower limit is 1Cyc. If the specified Cycle is less than 1Cyc, the system will adjust the Cycle to 1Cyc automatically.

Trigger Period upper limit = 500.00s

The Trigger Period upper limit is 500.00s. If the specified Trigger Period is greater than 500.00s, the system will adjust the Trigger Period to 500.00s automatically.

Trigger Period lower limit = 1.0μs

The Trigger Period upper limit is 1.0μs. If the specified Trigger Period is less than 1.0μs, the system will adjust the Trigger Period to 1.0μs automatically.

Delay upper limit = 40.0s

The Delay upper limit is 40.0s. If the specified Delay is greater than 40.0s, the system will adjust the Delay to 40.0s automatically.

Delay lower limit = 0.000000000s

The Delay lower limit is 0.000000000s. If the specified Delay is less than 0.000000000s, the system will adjust the Delay to 0.000000000s automatically

Load Impedance upper limit = 10kΩ

The Load Impedance upper limit is 10kΩ. If the specified Load Impedance is greater

than 10k Ω , the system will adjust the Load Impedance to 10k Ω automatically.

Load Impedance lower limit = 1 Ω

The Load Impedance lower limit is 1 Ω . If the specified Load Impedance is less than 1 Ω , the system will adjust the Load Impedance to 1 Ω automatically.

Start Phase upper limit = +360.0 Degree

The Start Phase upper limit is 360.0°. If the specified Start Phase is greater than 360.0°, the system will adjust the Start Phase to 360.0° automatically.

Start Phase lower limit = -360.0 Degree.

The Start Phase lower limit is -360.0°. If the specified Start Phase is less than -360.0°, the system will adjust the Start Phase to -360.0° automatically.

(denotes the parameter, the content of which will vary according to the setting.)**

Troubleshooting

1. If the screen does not turn on even if the generator is on, please follow the steps below:

- ① Check if the power is correctly connected.
- ② Check if the power switch is really on.
- ③ Restart the instrument after taking the above steps.
- ④ If it does not work correctly, contact **RIGOL** for our service.

2. If the settings are correct but no waveform is generated, please follow the steps below:

- ① Check if the Signal Line is correctly connected to the Output terminal.
- ② Check if the BNC works correctly.
- ③ Check if the Output button has been turned on.
- ④ Select **PowOn** → **Latest**, when all the above steps have been finished. Restart the instrument.

Chapter 5 Support & Service

Warranty

RIGOL warrants that the products it manufactured and sold will be free from defects in materials and workmanship for a period of three years from the date of shipment from an authorized **RIGOL** distributor. If a product proves defective within the guarantee period, **RIGOL** will provide repair or replacement as described in the complete warranty statement.

To arrange for service or obtain a copy of the complete warranty statement, please contact your nearest **RIGOL** sales and service office.

RIGOL do not provide any other warranty items except the one being provided by this summary and the warranty statement. The warranty items include but not being subjected to the hint guarantee items related to tradable characteristic and any particular purpose.

RIGOL will not take any responsibility in cases regarding to indirect, particular and ensuing damage.

Contact RIGOL

If you meet any ambiguity during operating our products, please contact **RIGOL** Technologies, Inc. or contact your local distributor.

Domestic: Please call

Tel: (8610)80706688

Fax: (8610)80720067

9:00 am –5: 00 pm from Monday to Friday

Or by e-mail:

support@rigol.com

Or mail to:

RIGOL Technologies, Inc.

156# CaiHe Village, ShaHe Town, ChangPing District, Beijing, China

Post Code: 102206

Overseas: Contact local **RIGOL** distributor or sales office.

For a list of worldwide service centers, visit our web site: www.rigol.com

Chapter 6 Appendix

Appendix A Specifications

All the specifications apply to the DG1000 Series Function/ Arbitrary Waveform Generator unless specified statement. To meet these specifications, two conditions must be satisfied first:

- The instrument must have operated continuously for more than 30 minutes within the specified operating temperature.
- You must perform the "Test" operation through the Utility menu if the operating temperature changes by more than 5 °C.

All specifications are guaranteed unless marked "typical"

Specifications

Frequency Characteristic (DG1021)	
Waveforms	Sine, Square, Ramp, Triangle, Pulse, Noise, DC, Arb
Sine	1 μ Hz to 20MHz
Square	1 μ Hz to 5MHz
Pulse	500 μ Hz to 3MHz
Ramp	1 μ Hz to 150kHz
White Noise	5MHz bandwidth (-3dB)
Resolution	1 μ Hz
Arb	1 μ Hz to 5MHz
Accuracy	Within 90 days: 10 ppm Within 1 year: 20 ppm, 18°C - 28°C
Temperature index	< 2 ppm/°C

Frequency Characteristic (DG1011)	
Waveforms	Sine, Square, Ramp, Triangle, Pulse, Noise, DC, Arb
Sine	1 μ Hz to 15 MHz
Square	1 μ Hz to 4MHz
Pulse	500 μ Hz to 2MHz
Ramp	1 μ Hz to 100kHz
White Noise	5MHz bandwidth (-3dB)
Arb	1 μ Hz to 4MHz
Resolution	1 μ Hz
Accuracy	Within 90 days: 10 ppm Within 1 year: 20 ppm, 18°C - 28°C
Temperature index	< 2 ppm/°C

Sine Wave Spectral Purity			
Harmonic Distortion		< 1 V _{PP}	> 1 V _{PP}
	DC to 20 kHz	-70 dBc	-70 dBc
	20 kHz to 100 kHz	-65 dBc	-60 dBc
	100 kHz to 1 MHz	-50 dBc	-45 dBc
	1 MHz to 10 MHz	-40 dBc	-35 dBc
Total Harmonic Distortion	DC to 20 kHz	0.04%	
Spurious (non-harmonic)	DC to 1 MHz	< -70 dBc	
	1 MHz to 10 MHz	< -70 dBc + 6 dB/octave	
Phase Noise	10kHz Offset -115 dBc / Hz, typical		

Square Wave Characteristic		
Rise/Fall Time	< 20 ns (10% to 90%)	
Overshoot	< 2%	
Duty Cycle	1μHz to 3MHz	20% to 80%
	3MHz(not contain) to 4MHz	40% to 60%
	4MHz (not contain) to 5MHz	50%
Asymmetry (below 50% Duty Cycle)	1% of period+ 50ns	
Jitter	6ns + 0.1% of period	

Ramp Wave Characteristics	
Linearity	< 0.1% of peak output
Symmetry	0% to 100%

Pulse Wave Characteristics	
Pulse Width	2000s max period;20ns min period; 10ns resolution
Overshoot	< 2%
Jitter	6ns + 100ppm of period

Arb Wave Characteristics	
Waveform Length	2~4 K points
Amplitude Accuracy	14 bits (including sign)
Sample Rate	100MSa/s
Minimum Rising /Falling Time	35ns
Jitter (RMS)	6 ns + 30ppm
Non-Volatile Storage	4 waveforms

Output Characteristics	
Amplitude	2 m V _{PP} - 10 V _{PP} (50 Ω) 4 m V _{PP} - 20 V _{PP} (High Z)
Amplitude Accuracy (1 kHz)	± 1% of setting ± 1 mV _{PP}
Amplitude Flatness (sine wave relative to 1 kHz)	<100KHz 0.1 dB (± 1%)
	100KHz ~ 5MHz 0.15 dB (± 1.5%)
	5MHz ~ 20MHz 0.3 dB (± 3.5%)

DC Offset	
Range (peak AC+DC)	±5V (50Ω) ±10 V (High Z)
Accuracy	± 2% of the Offset Setting ± 0.5% (V _{offset}) of the Amplitude ± 2mV

Waveform Output	
Impedance	50 Ω typical
Protection	Short-circuit protected; Overload disables the output automatically
AM Modulation	
Carrier Waveforms	Sine, Square, Ramp, Arb
Source	Internal/ External
Modulating Waveforms	Sine, Square, Ramp, Noise, Arb (2mHz to 20kHz)
Depth	0% - 120%

FM Modulation	
Carrier Waveforms	Sine, Square, Ramp, Arb
Source	Internal/ External
Modulating Waveforms	Sine, Square, Ramp, Noise, Arb (2mHz to 20kHz)
Frequency Deviation	DC to 5 MHz
PM Modulation	
Carrier Waveforms	Sine, Square, Ramp, Arb
Source	Internal/ External
Modulating Waveforms	Sine, Square, Ramp, Noise, Arb (2mHz to 20kHz)
Phase Deviation	0 to 360°
FSK Modulation	
Carrier Waveforms	Sine, Square, Ramp, Arb
Source	Internal/ External
Modulating Waveforms	50% duty cycle square (2mHz to 50kHz)
Sweep	
Carrier Waveforms	Sine, Square, Ramp, Arb
Type	Linear or Logarithmic
Direction	Up or Down
Sweep Time	1 ms to 500 s \pm 0.1%
Source	Internal/External/Manual
Burst	
Waveforms	Sine, Square, Ramp, Pulse, Noise, Arb
Types	Count (1 to 50,000 periods), infinite, gated
Start Phase	-360° to +360°
Internal Period	1 μ s – 500s \pm 1%
Gate Source	External Trigger
Trigger Source	Internal/External/Manual

Rear Panel Connector	
External AM Modulation	\pm 5 V _{PK} = 100% modulation 5k Ω input impedance
External Trigger	TTL-compatible

RIGOL

Trigger Input	
Input Level	TTL-compatible
Slope	Rising or falling (selectable)
Pulse Width	> 100 ns
Input Impedance	> 10 k Ω , DC coupled
Linear Sweep	< 500 μ s (typical)
Latency Sweep	< 500 ns (typical)

Trigger Output	
Level	TTL-compatible into >1k Ω
Pulse Width	> 400ns typical
Output Impedance	50 Ω , typical
Maximum Rate	1 MHz

Counter Specification			
Function	Frequency, period, positive/negative Pulse width, Duty cycle		
Frequency range	Single channel: 100mHz ~ 200MHz		
Frequency resolution	6 digits/second		
Voltage range and sensitivity (not modulated signal)			
AUTO mode:	1Hz to 200MHz	200 mV _{PP} to 5 V _{PP}	
Manual mode	DC	DC offset range	± 1.5 V _{DC}
		100mHz to 100MHz	20m V _{RMS} to ± 5 V _{ac+dc}
		100MHz to 200MHz	40m V _{RMS} to ± 5 V _{ac+dc}
	AC	1Hz to 100MHz	50m V _{PP} to ± 5 V _{PP}
		100MHz to 200MHz	100m V _{PP} to ± 5 V _{PP}
Pulse width and Duty cycle measure	1Hz to 10MHz (100mV _{PP} ~ 10V _{PP})		
Input adjust	Input impedance	1M Ω	
	Coupling mode	AC、DC	
	High frequency restrain	High frequency noise restrain (HFR) on or off	
	sensitivity	Low, Medium, High	

Trigger mode	The trigger level can adjust manually/ automatically
	Trigger level range: ± 3 V (0.1% to 100%)
	Resolution: 6 mV

General Specifications

Display	
Type	Black and White LCD Screen
Resolution	256 Horizontal x 64 Vertical
Grey Degree	4 Grey Level
Contrast (typical)	150 : 1
Light (typical)	300 nit

Power	
Supply	100-240 VAC _{RMS} , 45-440Hz, CAT II
Consumption	Less than 40W
Fuse	2A, T Level , 250V

Environment	
Temperature Range	Operation: 10°C~+40°C
	Non-operation: -20°C~+60°C
Cooling	Mandatory Force cooling
Humidity Range	Below +35°C: ≤90% relative humidity
	+35°C~+40°C: ≤60%relative humidity
Height Range	Operation : below 3,000m
	Non-operation: below 15,000m

Instrument Specifications		
Dimension	Width	232mm
	Height	108mm
	Depth	288mm
Weight	Package excluded	2.65 Kg
	Package Included	4Kg

IP Protection	
IP2X	

Calibration Interval	
One year suggested	

Appendix B DG1000 Series Accessories

Standard Accessories:

- A Power Cord that fits the standard of the destination country.
- USB Data Wire
- A set of Ultrawave Arbitrary Waveform Edition Software for WIN98/2000/XP
- A 《User' Guide》
- A product service card

Optional Accessories:

- A BNC Cable

All the accessories (standard and optional) can be purchased by contacting your local RIGOL office.

Appendix C General Care and Cleaning

General Care

Do not store or leave the instrument in the place where the LCD display will be exposed to direct sunlight for long periods of time.



CAUTION: To avoid damage to the instrument or probes, do not expose them to sprays, liquids, or solvents.

Cleaning

Check the Instrument and Probe frequently according to the operation conditions; follow the steps below to clean the exterior surface of the instrument:

1. Wipe the dust on the outside of the instrument and probes with a lint-free cloth. Take care to avoid scratching the clear plastic display filter.
2. Use a soft cloth dampened with water to clean the instrument. Please disconnect the power. To avoid damage to the surface of the instrument or probes, do not use any abrasive or chemical cleaning agent.



Warning: To avoid any short-circuit or body damage because of the moisture, make sure that the instrument is dry before restarting the instrument.
